

I.C.
PASSEDANNUAL
NUMBER
OVER 100 PROJECTS
77 + SEPTEMBER 1989

elektor

INDIA

Rs. 20.00

electronics



THE CHANGING ROLE OF
PUBLIC TELECOM OPERATORS
MEDICAL
ELECTRONICS FROM L & T
FINDING FAULTS
NO PROBLEM
AI
TRANSPLANT

SPECIAL FEATURES

- 9.07 EDITORIAL: Hacking(Fun or Evil?)
- 9.18 AI Transplant
- 9.27 The changing role of public telecom operators
- 9.30 Medical electronics from L & T
- 9.41 Finding faults, No problem
- 9.45 News
- 9.120 New products

AUDIO & HI-FI

- 9.50 Balance indicator (001)
- 9.55 Recording control (009)
- 9.57 4-channel mixer (014)
- 9.59 Bucket brigad delay line (019)
- 9.62 Tuneable band-pass filter (022)
- 9.66 Sound level attenuator (030)
- 9.80 A simple VOX (053)
- 9.80 Low-noise microphone preamplifier (054)
- 9.112 Voice-band filter (096)

CAR ELECTRONICS

- 9.51 Car lights monitor (003)
- 9.62 Car headlight control (023)
- 9.71 Energy control for battery charges (039)
- 9.72 Car alarm (041)
- 9.74 Psychological car lock (043)
- 9.79 Improved low-fuel indicator (052)
- 9.89 Rear window wiper coupler (067)
- 9.96 Rear wash-wipe control (077)

COMPONENTS

- 9.63 BICMOS integrated circuits (025)
- 9.67 Fast unity gain opamp (031)
- 9.117 Decoupling power rails (103)
- 9.115 R-2R resistance network in SMT (100)

COMPUTERS

- 9.50 Reset for the PC1640 (002)
- 9.55 Child-proof reset switch (010)
- 9.58 MSX EPROM (015)
- 9.63 Reset protection (024)
- 9.68 Printer reset (032)
- 9.71 I/O-friendly keyboard (038)
- 9.77 Monitoring temperature with the C64 (049)
- 9.89 Pulse skipper (068)
- 9.91 Daylight-resistant optocoupler (070)
- 9.95 RS 232 Interface for C64 (076)
- 9.98 One or two MBIT Eprom programmer (081)
- 9.104 Small I/O card (087)
- 9.110 Automatic printer sharing (095)

ELECTROPHONICS

- 9.51 Vocal eliminator (004)
- 9.68 Variable low-pass filter (033)
- 9.87 Guitar compressor (064)
- 9.99 MIDI interface for Amiga (082)
- 9.116 Break-jack adaptor (101)
- 9.118 Modular guitar amplifier (105)

GENERAL INTEREST

- 9.54 Sound level meter (008)
- 9.52 Power booster for 7406/7407 (005)
- 9.56 "On" indicator (011)
- 9.59 Simple temperature indicator (018)
- 9.64 Programmable switch (026)
- 9.69 Automatic switch (034)

- 9.70 Head/tail lights for model railway (037)
- 9.73 Twilight switch (042)
- 9.75 X-Y plotter interface (044)
- 9.75 Timer with audible warning (045)
- 9.79 Heating timer (051)
- 9.81 High-volume alarm (055)
- 9.82 Mains-powered timer (056)
- 9.83 Single-chip melody generator (057)
- 9.83 Infra-red microphone (058)
- 9.84 Four-quadrat dimmer (059)
- 9.84 Sensor switch and clock (060)
- 9.85 Mini-drill control (061)
- 9.86 Mains failure indicator (063)
- 9.90 Flashing-light control (069)
- 9.92 Improved economical porch light (071)
- 9.92 Ringing pruner (072)
- 9.94 EEPROM (074)
- 9.95 LED Voltmeter in SMT (075)
- 9.97 Differential amplifier (078)
- 9.100 Automatic charger add-on unit (083)
- 9.101 Smoke detector (084)
- 9.105 Liquid-level monitor (089)
- 9.106 'On' indicator for gas-operated fridges (090)
- 9.107 Automatic fog horn (091)
- 9.112 Slide fader update (097)
- 9.114 Time-delayed flash (099)
- 9.118 Light (S) out? (104)
- 9.119 Donald duck generator (106)

POWER SUPPLIES

- 9.52 78xx monitor (006)
- 9.56 9-volt supply (012)
- 9.65 Switch-mode voltage regulator (027)
- 9.69 Low dissipation regulator (035)
- 9.76 High-power zener diode (047)
- 9.78 Simple variable power supply (050)
- 9.93 Small step-up converter (073)
- 9.98 Power supply with EEPROM (080)
- 9.109 Symmetrical power supply (094)
- 9.113 Reference-voltage source with indicator (098)
- 9.116 Maximum/minimum voltage indicator (102)

RADIO & TV

- 9.53 Radio beacon converter (007)
- 9.58 Universal squelch (016)
- 9.60 Fast envelope sampler (020)
- 9.65 2-metre transmitter (028)
- 9.86 Call tone generator (062)
- 9.102 VFO stabilizer for up to 100 MHz (085)
- 9.107 Headphone amplifier with scart plug (092)

TELECOMMUNICATIONS

- 9.70 Duplex audio link (036)

TEST & MEASUREMENT

- 9.56 ABS/RMS/LOG converter (013)
- 9.59 48 MHz CMOS oscillator (017)
- 9.61 Noise generator (021)
- 9.66 Meter-scale magnifier (029)
- 9.72 TTL supply monitor (040)
- 9.76 HCMOS square wave generator (046)
- 9.77 Voltage-controlled oscillator (048)
- 9.88 LC sine wave generator (065)
- 9.88 Shunt for multimeter (066)
- 9.97 HF probe for oscilloscope (079)
- 9.103 Crystal tester (086)
- 9.104 Voltage tracer in SMT (088)
- 9.109 Digital trigger for oscilloscopes (093)

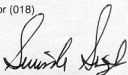

Publisher: C.R. Chandarana
Editor: Surendra Iyer
Circulation/Advertising: J. Dhas
Production: C.N. Mithagari

Address:
ELEKTOR ELECTRONICS PVT. LTD.
52, C Proctor Road, Bombay-400 007 INDIA
Telex: (011) 76661 ELEK IN

OVERSEAS EDITIONS

Elektor Electronics
(Publishing)

Down House, Broomhill Road,
LONDON SW18 4JQ

Editor: Len Seymour

Elektor sarl
Route Nationale, Le Seau; B.P. 53
59270 Baillieu - France
Editors: D R S Meyer;
G C P Raedersdorf

Elektor Verlag GmbH
Süsterfeld-Strasse 25
5100 Aachen - West Germany
Editor: E J A Krempelsauer

Elektor EPE
Karaiskaki 14
16673 Voula - Athens - Greece
Editor: E Xanthoulis

Elektuur B.V.
Peter Treckpoelstraat 2-4
6191 VK Beek - the Netherlands
Editor: P E L Kersemakers

Electro-shop
35 Nasseem Plaza
Lasbella Chawk
Karachi 5 - Pakistan
Manager: Zain Ahmed
Ferreira & Bento Lda.
R.D. Estefania, 31-1°
1000 Lisboa-Portugal
Editor: Jeremias Sequeira

Ingelek S.A.
Plaza Republics Ecuador
2-28016 Madrid - Spain
Editor: A M Ferrer
Electronic Press AB
Box 5505
14105 Huddinge - Sweden
Editor: Bill Cedrum

The Circuits are domestic use only. The submission of designs or articles implies permission to the publisher to alter and translate the text and design and to use the contents in other Elektor Publications and activities. The publishers cannot guarantee to return any material submitted to them. Material must be sent to the Holland address (given above). All drawings, photographs, printed circuit boards and articles published in elektor publications are copyright and may not be reproduced or imitated in whole or part without prior written permission of the publishers.

Patent protection may exist in respect of circuit devices, components etc. described in this magazine.

The publishers do not accept responsibility for failing to identify such patent or other protection.



Printed at : Trupti Offset Bombay - 400 013

Copyright © 1989 Elektuur B.V.

ANNUAL NUMBER
SEPTEMBER 1989
VOLUME-7
NUMBER-9

HACKING: FUN OR EVIL?

There are indications that hacking, the nefarious accessing of computers, is becoming more widespread. There are many who in their naivety consider that this anti-social behaviour is nothing but a bit of fun whose perpetrators do a useful job in testing the security of computer systems. Nothing could be further from the truth.

A hacker is someone who, without permission, enters your home as it were and goes through your personal belongings. While doing so, he may, innocently or intentionally, take copies of your computer files. He may destroy or corrupt them. He may unwittingly plant an electronic time bomb that does not go off till much later.

There is no way of knowing exactly the harm and damage caused to private computer systems, but it is estimated, and in a number of countries a documented fact, that industrial and commercial losses world-wide amount to thousands of millions of pounds. More seriously, deaths have already occurred owing to the (hopefully inadvertent) changing of medical records by hackers infiltrating a French hospital computer system. And nobody knows how many cases of blackmail have been, or are being, conducted as the direct result of a hacker's activities.

It is, of course, true that many computer owners to a large extent have only themselves to blame. After all, you don't leave your car unlocked parked anywhere in a big (or even small) town nowadays. Nor do you leave the front door of your home open so that people can just walk in. That is, of course, no reason for anybody to take your car or enter your home, but it does hand them the opportunity of so doing on a plate. Considering the cost of a computer system, and the possible losses caused by hacking, the cost and trouble of making the system secure are relatively small.

Many may argue that the laws should be changed to deal with hackers, but that will not be the whole answer any more than it is in the case of other kinds of crime. Nevertheless, a change in the law is overdue, if only because it will at least reflect the attitude of the nation to hacking, an activity that is at best irresponsible, invariably harmful, and often destructive.

BALANCE INDICATOR

If your amplifier is fitted with two balance controls (as, for instance, the Elektor Electronics Preamplifier for Purists - Ref. 1), it actually offers you a balance control and a level control. A drawback of this is that it is quite difficult to set the balance properly. This may be obviated, however, by replacing the two mono potentiometers by stereo versions, P1a and P2 in the diagram.

One half of the pair, P1a and P2a, assumes the tasks of the removed components. The other half is connected in a bridge circuit. The voltage between the wipers of the potentiometers is then a measure of the balance between the two channels. The lower the potential, the better the balance. If you are interested in knowing the degree of unbalance, connect a centre-zero moving coil meter with a bias resistor between A and B. With this arrangement, zener diodes D1 and D2 may be omitted: they are

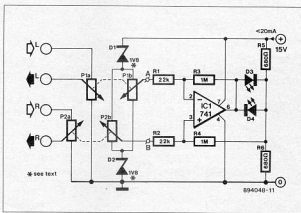

necessary only with the LED indicator shown in the diagram to prevent the input voltage of the opamp getting too close to the level of the supply voltage.

The circuit around IC1 is a classical differential amplifier. Resistors R5 and R6 provide a virtual earth for the LEDs, which is necessary to ensure that in spite of the asymmetrical supply voltage a positive and a negative output is obtained.

Since the LEDs have been included in the feedback loop of the indicator, the circuit is pretty sensitive. At only 40 mV, that is, just one fourhundredth of the supply voltage, one of the LEDs begins to light already. The maximum current drawn by the LEDs is determined by the values of R5 and R6.

supply voltage, one of the LEDs begins to light already. The maximum current drawn by the LEDs is determined by the values of R5 and R6.

Ref. 1. "Elektor India November 1988"

RESET FOR THE PC 1640

The PC1640 is one of Amstrad's popular and successful series of compact PCs. It has, unfortunately, a serious deficiency: there is no reset control. Luckily, it is not too difficult to fit this control retrospectively, since every PC, and the 1640 is no exception, has a reset circuit.

In the 1649, the circuit shown below monitors the level of the supply voltage. This voltage is sampled by potential divider R151-R152-R176-R188. If the supply is too low, the Q105, and consequently the Q104, switches off. Transistor Q106 is also provided with too little bias voltage to conduct. The enable input of the CMOS memory, IC134, is linked to the collector of Q105, so that when Q105 is turned off, the memory is disabled. At the same time, the supply to the memory is switched off since Q104 is off.

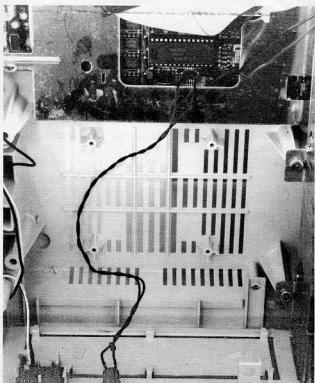
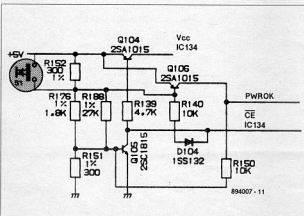

Only when the supply voltage is at the correct level does Q105 conduct. At the same time, Q104 and Q106 are provided with sufficient base current to switch on. This causes the supply to IC134 to be switched on, which results in the removal of the inhibit on the enable input. The processor receives a signal, PWROK, indicating that the supply level is all right, so that the reset cycle can start. The entire computer is initialised, while all I/O lines are set as required.

To fit a reset control, use is made of the PWROK signal in the following manner. If R152 is short-circuited, PWROK goes low and the

processor is reset. Only when PWROK has gone high again will the processor start the reset routine. This is exactly the same cycle that occurs when the computer is restarted. In other words, all the reset control needs to do is to short-circuit R152.

The reset facility is incorporated fairly easily by fitting at some convenient place on the computer a simple push-button switch with a make contact. Connect the two terminals of the switch to the two ends of R152 (clearly marked on the PCB) via two short lengths of flexible wire and that's all.

003

CAR ELECTRONICS

CAR LIGHTS MONITOR

A defect car light is at best a nuisance and at worst a danger. Fortunately, most new cars are equipped with suitable monitors that indicate on the dashboard whether a light is not working. There are, of course, millions of older cars that have no such sophistication and it is for these that the present monitor is intended.

Two special ICs are available from Telefunken that are designed for measuring the current through a light bulb. In practice, detecting whether a current flows through a bulb or no is a most suitable way of determining whether the bulb still works.

If a small resistance is connected in series with the bulb, a small voltage drop will develop across it when the bulb lights (R1 and R2 in the diagram). Each IC can cope with only two bulbs, so that per car three or four ICs are needed. The junction of the bulb and resistor is connected to one of the inputs (pin 4 or pin 6) of the IC. The potential across the resistor is compared in the IC with an internal reference voltage.

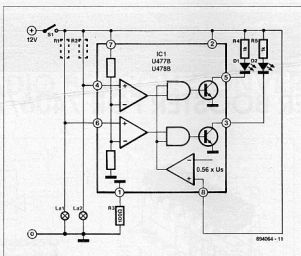

Depending on which of the two ICs is used, the voltage drop must be about 16 mV (U477B) or 100 mV (U478B). This voltage drop is so small that it will not affect the brightness of the relevant bulb.

The value of the series resistor is determined quite easily. If, for instance, it is in series with the brake light (normally 21 W), the current through the bulb, assuming that the vehicle has a 12 V battery, is $21/12=1.75$ A. The resistance must then be $16/1.75=9$ mΩ (U477B) or $100/1.75=57$ mΩ (U478B).

These resistors may be made from a length of resistance wire ((available from most electrical retailers). Failing that, standard circuit wire of 0.7 mm dia. may be used. This has a specific resistance

of about 100 mΩ per metre. However, in most cars the existing wiring will have sufficient resistance to serve as series resistor.

LEDs may be connected to the outputs of the IC (pins 3 and 5). These will only light if the relevant car light fails to work properly.

004

ELECTROPHONICS

VOCAL ELIMINATOR

Otherwise properly mixed sounds often suffer from a predominant solo voice (which may, of course, be the intention). If such a voice needs to be suppressed, the present circuit will do the job admirably.

The circuit is based on the fact that solo voices are invariably struated "at the centre" of the stereo recordings that are to be mixed. This means that the voice levels in the left- and right-hand channels are about equal. Arithmetically, therefore, left minus right is zero, that is, a mono signal without voice.

There is, however, a problem: the sound levels of bass instruments, more particularly the double basses, are also just about the same in the two channels. This is because on the one hand low-frequency sounds are virtually non-directional and on the other hand, the recording engineers purposely use these frequencies to

give a balance between the two channels.

However, the bass instruments may be recovered by adding those appearing in the left+right signal to the left-right signal. The whole procedure is easily followed in the circuit diagram. The incoming stereo signal is buffered by A1 and A2. The buffered signal is then fed to differential amplifier A3 and subsequently to summing amplifier A5. The latter is followed by a low-pass filter formed by A6. You may choose between a first-order and a second-order filter by respectively omitting or fitting C2. Listen to what sounds better.

The low-frequency signal and the difference signal are applied to summing amplifier A4. The balance between the two is set by P1 and P2 to individual taste.

You may have noticed that the circuit does not contain input

or output capacitors. If you wish, output capacitors may be added without detriment. However, the fitting of input capacitors is not advisable, because the consequent phase shift would adversely affect the operation of the circuit.

(A. Roelen)

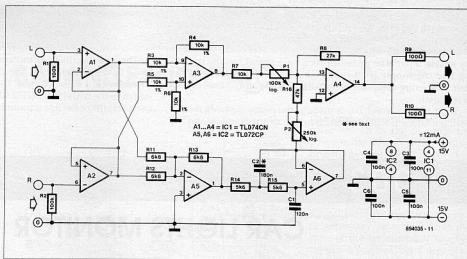

005

GENERAL INTEREST

POWER BOOSTER FOR 7406/7407

It often happens that a digital signal is required for controlling a relay, a stepper motor, or other kind of relatively heavy load. This makes it necessary for both the output current and the output voltage of the relevant device to be increased. Some logic devices are provided with constant-voltage open-collector outputs, but these are invariably restricted to 15 V or 30 V.

With a little dexterity, it is possible to provide a 7406 or 7407 with a dedicated open-collector output - see Fig. 1. If you aim for the construction in Fig. 2, the result will take not much more space than a standard 7406. Since the output stage inverts, it is necessary to use the non-inverting 7407 to obtain an inverted output.

The transistor must be chosen in accordance with the wanted output. For most general purposes, the BC546 is perfectly satisfactory (200 mA at 65 V).

(A. Schaffert)

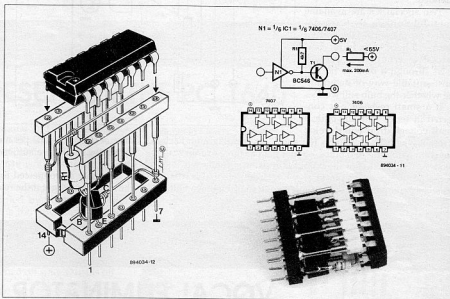

006

POWER SUPPLIES

78XX MONITOR

When a voltage regulator is supplied from a mains adapter, it sometimes happens that its output is too low (because the output from the adapter is too low, or because the voltage has dropped to a low value owing to an overload). It is useful if a warning of that

situation is indicated.

The proper operation of the 78xx series of regulators depends on the difference between input and voltage voltage, which must be not less than 3 V (worst case; many regulators are much better).

The voltage drop across the regulator is monitored by IC1. The input and output voltage of the regulator are supplied to IC1 via potential dividers. If the input voltage to the regulator is too low, IC1 goes high, which causes C1 to charge and this turns on T1, so that D2 lights. You may, of course, use a buzzer instead of D2 and R7. The charge on C1 ensures that the LED lights for at least 10 ms. This means that the circuit will react to even very short voltage drops at the input of the regulator. A large ripple that results in a too low input voltage is therefore clearly indicated. The circuit is based on the 7805; the value of R1 must be redesigned for other members of the 78xx series by the following:

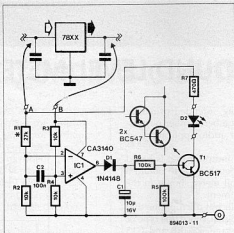

$$R1 = [(2U_i / U_r) + 1] / R2$$

where U_i is the voltage drop across the regulator and U_r is the characteristic output voltage of the regulator. It is necessary that dU is chosen somewhat larger than the actual minimum voltage drop across the regulator to prevent non-operation of the circuit. This is so because the minimum voltage drop across the regulator is constant when the device ceases to function properly until the input voltage returns to normal. In other words, the monitor must be able to react to a voltage drop that is slightly higher than the minimum voltage drop.

007

RADIO & TV

RADIO BEACON CONVERTER

The radio beacon band extends from 280 kHz to 516 kHz. Each beacon has its own characteristic AM modulated morse-coded call sign that is transmitted on a specific frequency. To be able to receive distant beacons, the aerial signal is passed through a band-pass filter that effectively suppresses long-wave and medium-wave signals. The filter also converts the aerial impedance, Z_{in} , from about 10 k Ω to the input impedance of mixer IC1, which is about 1 k Ω .

The mixer adds or subtracts the received signal to/from the local oscillator signal, so that the beacon signal can be received on a normal short-wave receiver. The resulting frequencies lie in the range 9.72-9.484 MHz or 10.280-10.516 MHz.

In the construction of the converter some components must be surrounded by a metal shield as indicated by dashed lines on the PCB layout.

The circuit is aligned with the aid of an SW receiver to which the output of the converter is connected. Tune the receiver to 10 MHz and adjust the oscillator frequency of the converter by means of C8 for zero beat. Next, detune the receiver slightly until a pleasant whistle is heard, which is adjusted for minimum level with the aid of P1. Finally, tune to a beacon transmitting at or about 300 kHz and adjust C13 for maximum sound output.

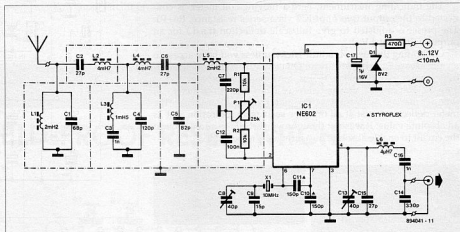

Capacitors:

- C1 = 68 pF
- C2; C6; C15 = 27 pF
- C3; C16 = 1 nF
- C4 = 120 pF
- C5 = 82 pF
- C7 = 220 pF
- C8; C13 = 40 pF trimmer
- C9 = 15 pF
- C10; C11 = 150 pF styroflex
- C12 = 100 nF
- C14 = 330 pF
- C17 = 1 μ F; 16 V

Inductors:

- L1; L5 = 2.2 mH
- L2; L4; L6 = 4.7 mH
- L3 = 1.5 mH

Semiconductors:

- D1 = zener diode 8.2 V
- IC1 = NE602

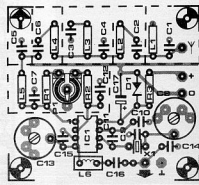

Miscellaneous:

- X1 = 10 MHz crystal; 30 pF parallel resonance

Parts list

- Resistors:**
 R1; R2 = 10 k Ω
 R3 = 470 Ω
 P1 = 25 k Ω preset potentiometer

SOUND LEVEL METER

Although the NE604 is, strictly speaking, intended primarily for h.f. applications, it may be used for a number of other purposes. One of these is a sound level meter for audio applications as presented here.

Use is made of the IC's signal-strength indicator that is based on an internal logarithmic converter. This enables us to obtain a linear decibel scale, so that the moving-coil meter shown in the diagram may be replaced by a digital instrument.

The signal source is assumed to be an electret microphone that converts ambient noise into an electrical signal. Since this type of microphone normally contains a buffer stage, R7, R8 and C13 have been included to provide the supply voltage for this stage.

The NE604 delivers an output current (at pin 5) of 0–50 μ A, which causes a potential difference across R2+R3 of 0–5 V. The range over which the relation between input and output signal is logarithmic is, however, slightly smaller: about 0–4 V. This is equivalent to a sound range of 70 dB.

To compensate the effects of temperature changes, the required resistance of 100 k Ω is formed by two resistors, R2 and R3, and a diode, D1.

Any ripple remaining on the output voltage is removed by R4-C9-C10 before the output is buffered by IC2.

The indicating instrument, here a moving-coil meter, is connected to the output (pin 6) of IC2 via a series resistance, R6+P1. The preset is adjusted to give full-scale deflection (f.s.d.) for an output voltage of 4 V.

Calibrating the meter is a little tricky, unless you have access to an already calibrated instrument. Otherwise, if you know the efficiency of your loudspeaker, that is, how many decibels for 1 W at 1 metre, you can use that as reference. The scale of the meter can then be marked with the (approximate) value. In any case, the meter deflection must at all times be seen as an indication, not as an absolute value: it was not thought worthwhile to add a filter to the circuit to enable absolute measurements to be made.

Parts list

Resistors:

- R1, R6 = 2k Ω
- R2 = 60k Ω (E96) or two 120 k Ω resistors in parallel
- R3 = 40k Ω or 39 k Ω in series with 1 k Ω
- R4, R5 = 1 M Ω
- R7 = 1 k Ω
- R8 = 10 k Ω
- P1 = 10 k Ω preset potentiometer

Capacitors:

- C1 = 4 μ 7/63 V radial
- C2 = 15 n
- C3 = 220 μ /16 V radial
- C4–C7 incl. = 10 μ /16 V radial
- C8 = 47 μ /16 V
- C9, C14 = 100 n
- C10 = 4n7
- C11, C12 = 1 n
- C13 = 47 μ /10 V

Semiconductors:

- D1 = 1N4148
- IC1 = NE604
- IC2 = 3130

Miscellaneous:

- S1 = push-button switch with one make contact
- M1 = moving-coil meter; 1 mA

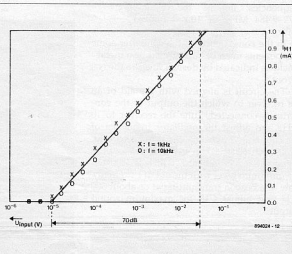
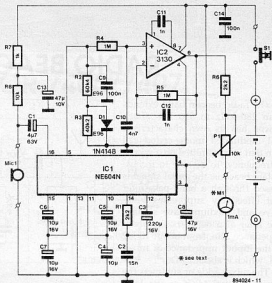
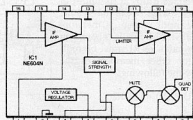
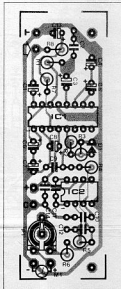

RECORDING CONTROL

The circuit presented here is intended as a recording control for cassette recorders. It enables the reading on the VU meters to be kept out of the red sector without the necessity of the recorder's level control to be adjusted. This is particularly useful when speech is recorded.

The recording signal is controlled via two voltage dividers, each containing a light-dependent resistor - LDR. Unfortunately, these devices introduce slight distortion, but that is still better than a lot of distortion through overloading of the tape.

The circuit monitors the signal level at the headphone output of the recorder. The signal there is rectified (half wave) and then applied to T1. The speed with which T1 can react is determined by C1. As shown, the attack time is set at 3 ms. The release time of the circuit is determined by R4-C4 and is much longer than the attack time: about 100 ms.

The voltage across C2 determines to what extent the signal to be recorded is attenuated. The charging current through R4 depends on the voltage across the capacitor, so that the light intensity of the LEDs is also dependent on the signal strength.

The light from D1 and D2 falls on R7 and R8, which form part of the potential dividers that are added to the input circuit of the recorder.

The circuit is easily disabled by opening S1.

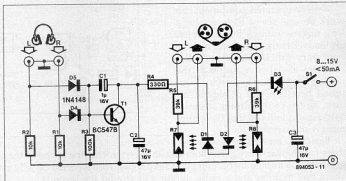

Owners of cassette recorder with separate recording and playback heads should bear in mind that the circuit does not work well if the internal monitor is switched on. In that situation, the signal takes a finite time to reach the headphone socket: too late for correcting the input signal level.

(S.G. Dimitriou and F.P. Maggana)

CHILD-PROOF RESET SWITCH

The reset switch on a computer is a very important control. If an operating instruction threatens to wreck the internal management of a computer, the reset button is often the only way of avoiding a possible disaster. On the other hand, it may also be the cause of a disaster. After all, one touch on it and hours of work may be negated in an instant, that is, if you do not save your work every fifteen minutes or so. None the less, anyone can have an accident, but it is particularly important that children or pets can not inadvertently operate the control.

The circuit proposed here should put an end to your worries in this respect. Instead of one reset switch, it is necessary to press four switches simultaneously. The chances of this happening by accident or child or pet are so small as to be negligible.

The four switches are placed

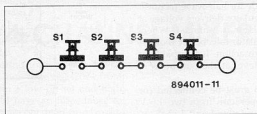

in positions that make it impossible to operate them all with one hand. Instead, two of them can be operated with the fingers of one hand and the other two with the fingers of the other hand.

As shown, the four switches are connected in series and are intended to replace the existing switch.



“ON” INDICATOR

Battery-operated equipment can work on one set of batteries for a long time nowadays. But if it is left on inadvertently, that 'long time' is over very quickly. Moreover, flat batteries are always found at the wrong moment. The circuit proposed here is a sort of aide-memoire. Every two minutes it emits 5-10 pips to indicate that the equipment is still switched on.

Basically, the circuit consists of three rectangular-wave generators and an inverter. The first of the generators is formed by N1 and provides a signal with a period of about two minutes and a pulse duration of around ten seconds. During those ten seconds, the second generator starts operating in a one-second rhythm. Thus, N2 outputs ten pulses every 2 min-

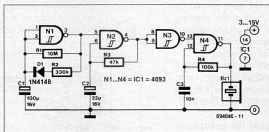

utes. That output is inverted so that N4, like N2, can only be enabled during the 10-second pulse train from N1. There is a difference, though: during those 10 seconds, N4 is enabled and inhibited ten times and this is what causes the pips.

Do not take the times and number of pulses too literally, because there are wide variances between ICs from different manufacturers. On

the other hand, component values are not critical, so that it is fairly easy to adapt the circuit to personal taste or requirements.

The buzzer may be a standard Toko type or equivalent.

Finally, the current drawn by the circuit is negligibly small.

(R. Kambach)

9-VOLT SUPPLY

The TL496 is an IC that is intended to produce a nominal 9-volt, that is 7-10 V, supply voltage from a variety of sources. This supply is perfectly adequate for many circuits.

The voltage source may be a 1.5 V battery, or two of them, or the secondary of a mains transformer.

To provide 7-10 V supply from these, the IC contains a series regulator and a switching regulator. The series regulator is connected actively like a transformer. A diode for half-wave rectification is also on board. When the series regulator delivers voltage at a satisfactory level, the switching regulator is inhibited. When, however, the output from the series regulator falls below requirement, the switching regulator comes into action. It is capable of generating a sufficiently high voltage level at the output from only one or two 1.5 V batteries.

The diagram shows how the TL496 must be connected for operation from one 1.5 V battery. For operation from two 1.5 V batteries, some modifications are necessary: pins 1 and 3 of the IC must be disconnected and left open, and the negative terminal of C1 must be disconnected from earth and instead be connected to pin 2 of the IC.

The circuit is eminently suitable for use with equipment that can also be supplied from the mains; normally, such equipment uses NiCd batteries. With the present circuit connected to the relevant terminals of the equipment, these batteries are recharged via D1. This occurs during the half cycle that is not used by the

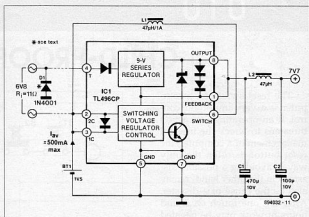

TL496. The charging current is determined by the internal resistance of the transformer (about 11 Ω , but note that this can not be measured with an ohmmeter). If you are in any doubt, connect a 10 Ω resistor in series with D1.

Finally, do not use D1 with dry batteries, because that would not do the batteries any good.

ABS / RMS / LOG CONVERTER

The converter is specially intended for use in audio applications for which the IC used, a Type SSM2210 from PDI, is particu-

larly suitable. The IC derives three voltages from the input signal: one corresponding to the absolute-ABS-value; one correspon-

ing to the root-mean square—RMS—value; and the third corresponding to the logarithmic—LOG—value of the input current, since the IC operates with currents. This makes possible a wide dynamic range: something like 100 dB. Translated in terms of input current, that gives 3 mA (p-p) to 30 nA (p-p). This makes it vital that C1 is a type with a very small leakage current.

The input voltage is converted into current by R1. With a value as shown for this component, the nominal input level is 0 dBV with a reserve up to +20 dBV.

Like the input signal, the output signals are currents that are converted into voltages by opamps A1, A2 and A3, which are connected as current/voltage amplifiers.

To enable the decibel scale to be calibrated accurately, a preset potentiometer, P1 has been included in the A3 stage.

With component values as shown in the diagram, the output voltage from A3 varies at about 33 mV/dB. It should be noted, however, that the dynamic range of the LOG output at 80 dB is rather narrower than the maximum possible 100 dB.

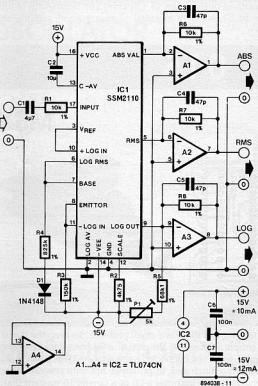

014

AUDIO & HI-FI

4-CHANNEL MIXER

The proposed mixer is designed around four current-driven transconductance amplifiers contained in a Type SSM2024 from Precision Monolithics Inc—PMI. To obtain a low off-set and high control rejection, the four inputs should have an impedance to earth of about 200 Ω . These impedances are obtained from resistors R5–R8 that also form part of a potential divider at each input.

With values as shown in the diagram, the nominal input signal is 1 V (0 dBV). Distortion at that level is about 1% and at lower levels not more than 0.3%.

The amplification of the current-driven amplifiers—CCAS—is determined by the current fed into the control inputs. These inputs form a virtual earth so that calculating the values of the bias resistors (to transform the inputs into voltage-driven inputs) is fairly simple.

With a value for R1–R4 of 10 k Ω , the CCAS are switched off if the potential at the control inputs is lower than 200 mV. Maximum amplification is obtained at a drive current of 500 μ A. The voltage at the control inputs is then slightly higher at 0.5 V, so that a maximum control voltage of 5.5 V is needed.

The output currents of the amplifiers are summed by simply linking the output pins (it is that simple with current outputs and completely in agreement with Kirchhoff's rules).

The current-to-voltage converter, IC2, translates the combined output currents into an output voltage. The value of R13 ensures that the amplification of IC2 is unity.

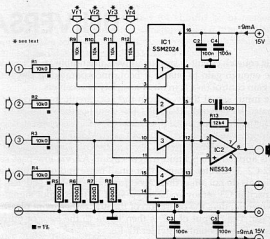

The current drawn by the mixer depends on the setting of the four CCAS and lies between 5 and 9 mA.

The signal-to-noise ratio of the mixer is about 90 dB, while the bandwidth is of the order of 130 kHz. The bandwidth is limited mainly by C1, which is essential to ensure good stability of the

current-to-voltage converter.

The SSM2024 operates satisfactorily with a supply voltage between ± 9 V and ± 18 V, but best results are obtained when it is ± 15 V.

015

COMPUTERS

MSX EPROM

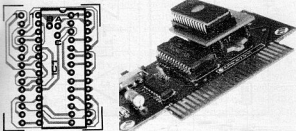

The "64 Kbyte RAM extension for MSX computers" (Ref. 1) can house EPROMs, but there is a small problem. To keep the board layout as simple as possible, the data and address lines on the extension board were not connected sequentially. With RAMs that does not matter too much and, in principle, not with EPROMs either, but their programming becomes a bit of a tangle. To prevent that, it is possible to use the auxiliary board shown here, which ensures that the address and data lines are connected to the correct pins of the IC. The board may be adapted to two types of EPROM by means of a wire link. With the link between A and B, a Type 27128 EPROM (16 K) may be used; if a 32 K EPROM is to be used, the link should be laid between A and C.

The two RAMs on the extension board each take two pages (a total of 32 K) in the address memory (pages 0/1 and 2/3 respectively). That means that when a Type 27128 EPROM is used, the

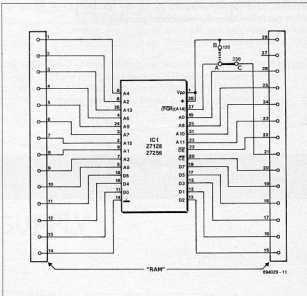

data occurs twice on both pages.

Ref. 1. "Elektor India October 1988"

016

RADIO & TV

UNIVERSAL SQUELCH

This squelch circuit is simple, universally usable and provides a large enough gain to enable it being incorporated in the automatic-gain control (AGC) circuit of a variety of receivers.

The input signal derived from the AGC circuit in a receiver is attenuated by network R1-R2-P1. The signal at the wiper of P1 is taken to the inverting input of opamp A1, which is connected as a comparator. The non-inverting input is provided with a reference voltage of 200 mV by potential divider R9-R10. The output signal of A1 is applied to a Schmitt trigger circuit, A2, via low-pass section R2-C2. This filter ensures that small noise and other interference signals do not affect the correct functioning of the squelch.

Capacitor C3 removes the steep skirt of the output signal of A2, which renders the operation of the AGC rather more pleasant to the ear. The output of A2 is then taken to the base of output transistor T1 via potential divider R7-R8.

The open-collector output of the squelch may be used to suppress the audio frequency output of the receiver.

Since the squelch draws only a small current, less than 10 mA,

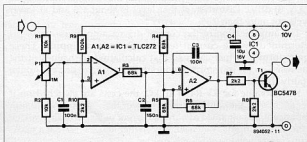

its incorporation into an existing receiver should not present any problems as far as the power supply is concerned.

(R. Lalic)

48 MHZ CMOS OSCILLATOR

Crystal oscillators using digital gates generally do not generate frequencies above 30 MHz, because the necessary crystals are not allowed to oscillate on their fundamental frequency.

In the oscillator shown here, the crystal is forced to oscillate on the third harmonic since it is connected in series with a parallel tuned circuit that resonates at the fundamental of 16 MHz. For digital applications, the output of N1 may be enhanced by the use of a second inverter.

The circuit will operate satisfactorily only if non-buffered CMOS devices are used. Gates from the HCU family will enable operation up to 60 MHz.

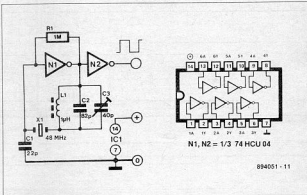

SIMPLE TEMPERATURE INDICATOR

For the absolute measurement of temperatures a thermometer is indispensable. There are, however, many situations where an absolute value is not needed and a relative indication suffices. The getting hot of an electric drill or vacuum cleaner may be indicated to the user by the lighting, or changing of colour, of a simple indicator light. It would be a further advantage if on such equipment a green light would indicate that all is well as far as temperature is concerned. As the temperature rises, the light should change colour slowly to indicate that the equipment is getting too hot.

The proposed circuit does this and has the additional advantage that it does not need a separate low-voltage supply; it works direct from the mains. The indicator proper is a two-colour LED, D1, while the sensor is a combination of a negative temperature coefficient (NTC) and a positive temperature coefficient (PTC) resistor, R4 and R3 respectively.

At a relatively low temperature, the value of R3 is low and that of R4 is high. During the positive half cycle of the mains voltage, a

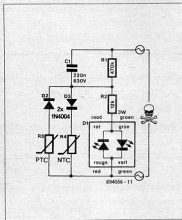

voltage will exist across R3-D3 that is sufficiently high to cause the green section of D1 to light. The value of R3 has been chosen to ensure that during the negative half cycle of the mains voltage the potential across it is too low to cause the red section of D1 to light.

If the temperature rises, the value of R4 diminishes and that of R3 rises. Slowly but surely the green section will light with lesser and lesser brightness, while at the same time the red section lights with greater and greater brightness until ultimately only the red section will light.

Resistor R2 and capacitor C3 ensure that the current drawn by the LEDs does not become too large. This arrangement keeps the dissipation relatively low.

Both R3 and R4 should be of reasonable dimensions, something like 6 mm in diameter – not less. At a temperature of 25°C, the NTC must have a value of 22–25 kΩ and the PTC one of 25–33 Ω.

The circuit should be treated with great care since it carries the full mains voltage.

BUCKET BRIGADE DELAY LINE

Although bucket-brigade devices (BBDs) are not in the same limelight as many other components, they do exist and are used. One of them, Type MN3004, consists of 512 capacitors and switching transistors. The IC is perhaps best described as an analogue

shift register. The capacitors are provided by the drain-gate capacitance of the transistors.

Samples of an analogue signal taken at the input appear 256 clock pulses later at the output. The clock pulses are obtained

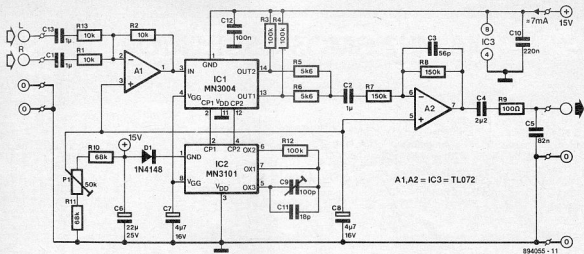

from an associated IC, a type MN3101. This IC also provides a supply voltage, V_{GG} , for the source followers in IC1. Note that the connections of the supply voltages to IC1 and IC2 have not been drawn incorrectly: V_{DD} must be negative with respect to earth (GND pin).

The MN3101 also makes it possible to construct an RC oscillator. Trimmer C9 enables varying the clock frequency and thus the delay time. It is also possible to connect an external oscillator to pin 7 (but note that pins 5 and 6 should be left open).

The clock frequency of the delay line may lie between 10 kHz and 100 kHz. With component values as shown in the diagram, it is about 60 kHz.

Maximum dissipation of the clock generator is about 200 mW, depending on the capacitive load of the memory. If more memories are used, it is possible to reduce the dissipation by connecting resistors in series with pins CP1 and CP2. Lowering the clock frequency will also reduce the dissipation.

The delay time of the circuit is equal to half the number of capacitors divided by the clock frequency: with values as shown, it amounts to 2.56–25.6 ms. The bandwidth of the delay line is roughly 0.33 times the clock frequency. Thus, with a clock frequency of 60 kHz, the bandwidth is 20 kHz and the delay more than 4 ms. In the prototype, these values yielded a signal-to-noise ratio of more than 70 dB and a distortion not exceeding 0.3% (at 1 kHz; 0 dBV). The current drawn was just over 6 mA, but this may increase to 14 mA with increased clock frequencies.

Apart from the delayed input signal, the output signal contains mixing products of the input and the clock. In the prototype (circuit as shown), with a clock of 60 kHz, these products were suppressed in the audio range by 60 dB (R8-C3 and R9-C5). It is, however, advisable when a lower clock is used to filter both the input and the output with a filter of at least the fourth order. Try to minimize the distortion by adjusting P1.

The delay line should find application in units for echo, tremolo, vibrator, chorus, reverb, and so on.

Another possibility is its use in a compressor to suppress, or at least attenuate, the short periods of overdrive. To that end, delay the input signal prior to the voltage-controlled amplifier (VCA) and

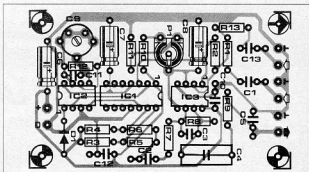

Parts list

Resistors:	C4 = 2μF
R1; R2; R13 = 10 k	C5 = 82 n
R3; R4; R12 = 100 k	C6 = 22μF; 25 V
R5; R6 = 5k6	C7; C8 = 4μF; 16 V
R7; R8 = 150 k	C9 = 100 p trimmer
R9 = 100 R	C10 = 220 n
R10; R11 = 68 k	C11 = 100 p
P1 = 50 k preset	C12 = 100 n
PC3; PC6 = PC2	
Capacitors:	Semiconductors:
C1; C2; C13 = 1 μF	D1 = 1N4148
C3 = 56 p	IC1 = MN3004
	IC2 = MN3101
	IC3 = TL072

drive the circuit that provides the control voltage for the VCA direct. In that application, the delay should be at least equal to the attack time of the compressor.

020

RADIO & TV

FAST ENVELOPE SAMPLER

When a signal is being amplitude-modulated, constant monitoring is necessary to ensure that the maximum modulating fre-

quency does not exceed half the carrier frequency. The fast envelope sampler presented here is basically an advanced AM

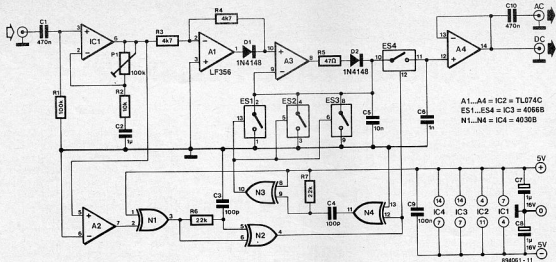

demodulator that can be used with modulations where the well-known diode detector with LF filter can not. Phase errors that occur with diode detection are absent in this circuit.

Amplifier IC1 is a buffer with variable (1-11) AC amplification. Opamps A1 and A3 form an active half-wave rectifier that charges capacitor C5 up to the maximum signal level in a half period.

During the zero crossing, detected by A2, the network around N2 generates a short pulse. This pulse ensures that the potential across C5 is applied to C6 via electronic switch ES4. After ES4 has been opened, so that the charge is stored safely in C6, capacitor C5 discharges via parallel-connected switches ES1-ES3 (which are actuated via the network around N3 and N4).

The output of the sampler is in accordance with the potential across C6. Basically, the circuit is frequency-independent since the clock signal is derived from the carrier. This is the reason that the sampler may be used in such diverse applications as satellite facsimile, radio receivers and speech processors.

The circuit may also be used to good effect in an AGC loop, because the classical problems regarding attack and delay associated with diode detection and LF filter systems do not occur in this type of demodulator.

Since in some applications a direct voltage is needed, for instance, in an AGC loop, the proposed circuit has a DC as well as an AC terminal.

The sampler is intended for operation from a ± 5 V supply and draws a current of about 20 mA.

021

TEST & MEASUREMENT

NOISE GENERATOR

The noise generator presented here provides constant noise energy over its bandwidth, resulting from the non-linear behaviour of its switching components, more particularly T4. It is very useful for measurements where limited noise bands are required. Varying the ratio R6:R7 and the clock frequency enables the generated noise to be adapted to specific requirements.

Transistors T2 and T3 are current sources. The current through T2 is about ten times the level of that through T3.

Assuming that T4 is on and that the clock input is low, T1 is off and C2 discharges. The capacitor is pulled to about half the supply voltage by the two current sources. When that state is reached, stability ensues because the potential then present at the gate of T4 keeps the FET switched on.

When the clock goes high, T1 is switched on so that C2 is connected between the gate of T4 and earth. Since C2 is only partly charged, the FET is switched off. Transistor T1 is kept switched on by OR gate D1-D2 so that the clock pulses are blocked. Capacitor C2 then charges via T3 until the potential across it becomes high enough to switch on T4. Transistor T1 is then switched off and the circuit is ready to receive another clock pulse (or rather a leading edge of one).

Since it is not known when the clock pulse arrives, it is not

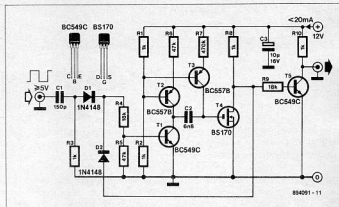

known to what potential C2 will be discharged by T2 (and countered by T3). It is therefore also not known how long it takes T3 to recharge C2. It follows that it is then not known when the next clock pulse arrives. In other words, the pulse width of the output signal is varying constantly, which is characteristic of a noise signal.

The frequencies contained in the noise signal are limited by the clock signal (higher frequencies than the clock can not occur, although there are harmonics) and the maximum charge and

TUNEABLE BAND-PASS FILTER

One of the difficulties in the design of higher-order tuneable band-pass filters is achieving correct tracking of the variable resistors in the RC networks. The use of switched capacitor networks can obviate that difficulty as is shown in this filter.

The filter may be divided roughly into two stages: an oscillator that controls the electronic switches and the four phase-shift networks that provide the filtering proper.

The oscillator, based on a 555, generates a pulsating signal whose frequency is adjustable over a wide range: the duty factor varies from 1:10 to 100:1.

Electronic switches ES1-ES4 form the variable resistors whose value is dependent on the frequency of the digital signal. The operation of these switches is fairly simple. When they are closed, their resistance is about 60 Ω ; when they are open, it is virtually infinitely high. If a switch is closed for, say, a quarter of the time, its average resistance is therefore 240 Ω . Varying the open:closed ratio of each switch varies the equivalent average resistance. The switching rate of the switches must be much greater than the highest audio frequency to prevent audible interference between the audio and clock signals.

The input signal causes a given direct voltage across C1, so that the opamps may be operated in a quasi-symmetric manner in spite of the single supply voltage.

The direct voltage is removed from the output signal by capacitor C10.

The fourth-order filter may be used over the

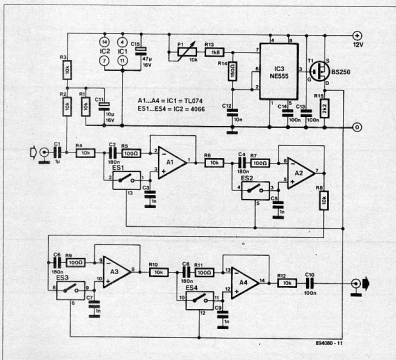

entire audio range and has an amplification of about 40, although this depends to some extent on the clock frequency. The bandwidth depends mainly on the set frequency.

The circuit draws a current of not more than 15 mA.

CAR HEADLIGHT CONTROL

It is an annoying fact that you normally only realize that you have left your car headlights on when you want to restart the car only to find that the battery is flat. One of the possible ways of preventing this happening is offered by the present control.

The circuit does not provide a warning but an action: when you switch off the ignition, relay Re1 is de-energized and the headlights are switched off, unless you deliberately decide otherwise. That decision is made possible by switch S1, which, when operated, triggers silicon-controlled rectifier Th1 so that Re1 is energized. Note that this is possible only when the ignition switch, S2, is off, otherwise the voltage across Th1 is so low, owing to shunt diode D1, that it can not be triggered. Since, however, the headlights should not normally be switched on when the ignition is off, in most cases S1 will be used only rarely and the switch may then well be omitted altogether.

Relay Re1 should be a standard 12 V car type with contacts that can switch up to 25 A.

(H. Huynen)

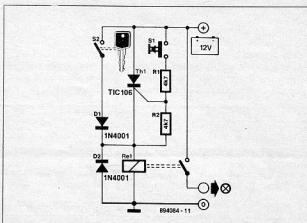

RESET PROTECTION

Most advanced computer programs include preventative measures against (possibly) hasty instructions. Responses such as "are you sure?" and "do you really want to quit?" are familiar to most of us. However, even the cleverest program can not prevent the inadvertent operation of the reset switch and the consequent result of lost data and improperly closed files that cause wasted clusters on the hard disk.

The location of the reset switch on the front panel of many computers asks, of course, for inadvertent operation. Clearly, some means of reset protection is no luxury.

Normally, the reset switch is connected to the mother board of the computer via two wires. One of these is at earth potential and the other is linked to the reset circuit. The protection, whose circuit is shown in the diagram, is inserted between the reset switch and the mother board. The earth connection of the computer must be linked to terminal M of the protection circuit. The protection circuit may draw its power from the computer supply.

When the circuit has been fitted, operation of the reset switch will not result in an immediate restart of the computer. Instead, a buzzer will sound to alert you to the reset operation. The buzzer is actuated for four seconds by monostable IC1a, which is triggered by the reset switch. During those four seconds, the output, pin 5, of IC1a ensures that the reset function, pin 10, of IC1b is dis-

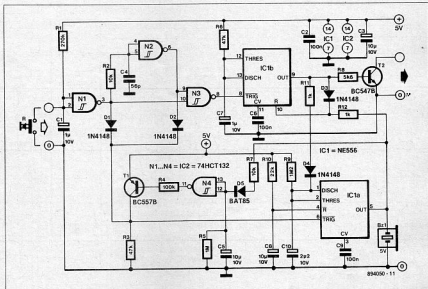

abled. When then the reset switch is operated again, monostable IC1b will be triggered and this will start the reset procedure. Transistor T2 is then switched on for half a second and the buzzer is deactivated via R11 and D4.

The circuit around T1 and N4 ensures that IC1a can accept trigger pulses again ten seconds after the mono time of IC1b has lapsed. This arrangement prevents, say, children operating the reset switch.

BICMOS INTEGRATED CIRCUITS

BICMOS devices combine bipolar and CMOS technologies, providing the best features of both: the fast performance and the 48/64 mA output drive of bipolar devices and the low power consumption of CMOS devices.

In active mode, BICMOS devices operate at about half the supply current of their pure bipolar equivalents. When disabled, they may reduce power consumption by up to 90%. Since at present most BICMOS ICs function as bus interfaces (that are normally disabled), the result may be a system IC-power saving of up to 25%.

Moreover, BICMOS devices use the typical 0.3-3.5 V TTL voltage swings at their output rather than the larger GND-to-VCC swings of CMOS devices. This smaller voltage swing reduces the overall effects of transient voltage noise produced during the simultaneous switching of multiple outputs.

A number of integrated circuits are available in BICMOS technology, including transceivers with registers, pipeline registers, 8/9/10-bit registers, latches and parity bus transceivers. These give the designer additional means of reducing power consumption without compromising advanced performance.

(Source: Texas Instruments)

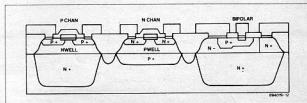
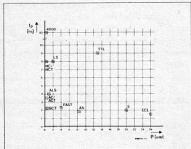

PROGRAMMABLE SWITCH

The programmable switch may be used, for instance, to simulate a data stream or, as shown, to control an analogue multiplexer, IC5. The multiplexer may be used as the basis of a programmable oscillator.

The circuit is based on National Semiconductor keyboard decoder Type MM74C922 (IC1). This device is intended to read a 4x4 matrix keyboard in a simple and fast manner. Apart from a 4-bit output, the IC also has a DATA AVAILABLE output, DA, which is high as long as one of the keys is pressed. The data associated with the last pressed key will remain on the output, even after the key has released. The speed with which the keyboard is scanned is determined by C1. When this capacitor has a value of 100 nF, as shown in the diagram, the scanning rate is 600 Hz. The anti-bounce period of the keyboard is determined by C2: with a value as shown, the period is about 10 ms (rule of thumb: $C2=10C1$).

The programming of the RAM, IC2, is fairly simple with the aid of IC1. First, the DA output of the decoder is inverted by N1 to enable it being used as the WRITE pulse. After the key has been released, the RAM is disabled ($DA=1, WE=0$), and the address counter, IC3, is clocked on by one address. Since the counter is a Type 4040, it reacts to trailing edges and this means that we has to be inverted again (by N4). It is not possible to use the original DA signal, since this could jeopardize the timing and cause non-defined states. The delay times of the gates ensure that all processes take place in correct sequence. Further delay is provided by the combination of R4 with the capacitance of the clock input.

The programmed data is read with the aid of a separate clock signal generated by an oscillator based on N3. The speed at which the data is read from the RAM is set by P1. Gate N3 is actuated by setting S18 in position A. Contact bounce here is prevented by the combination of R2 and C3, and the hysteresis of N3 and N2.

When S18 is in position A, gates N1 and N2 ensure that the RAM is in the read mode ($WE=1$). At the same time, N2 arranges that the data lines of the RAM are connected as outputs. Gate N4 ensures that either DA or the output of N3 is used as the clock for counter IC3. Furthermore, S18 also arranges the disabling of the data outputs of IC1 to prevent a bus conflict (the RAM now provides the data).

Pin 1 (Q11) of counter IC3 is connected to the clock input, pin 10, via OR network R4-D1 to ensure that the counter stops after one cycle. The stopping is indicated by the lighting of D1. Switch S17 enables the counter to be reset; it may also be used to set the counter to zero during programming.

When, during programming, the highest counter position is

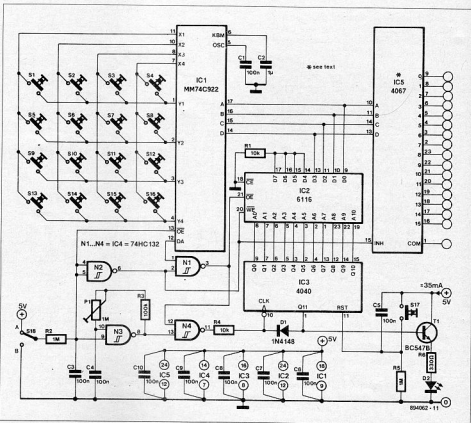

reached, the clock for the counter is disabled. Continued pressing of the keys will cause overwriting on to the last RAM address. To obtain a defined counter state on switch-on, network R5-C5 provides a power-on reset of the counter.

Only one half of the RAM is used, since four bits suffice for the proposed circuit. It is, therefore, possible to use a RAM with nibble configuration or use two keyboard encoders.

Finally, the use of 16 separate switches may make the circuit rather expensive: it is far cheaper to use a second-hand 4x4

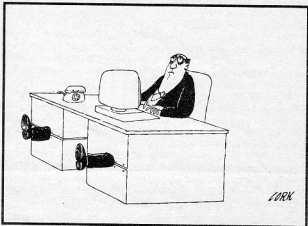

SWITCH-MODE VOLTAGE REGULATOR

Switch-mode power supplies offer the user the benefit of a much greater efficiency than obtainable with a traditional power supply. The switch-mode regulator presented here has an efficien-

cy of around 85%.

An input voltage of 12–16 V DC is converted into a direct voltage of exactly 5 V. The use of a Type MAX638CPA enables the design and construction of the regulator to be kept fairly simple: only nine additional components are needed to complete the circuit.

Resistors R1 and R2 are used to indicate when the battery voltage becomes low; as soon as the voltage on pin 3 becomes lower than 1.3 V, D1 lights. With values as shown for the potential divider, this corresponds to the supply voltage getting lower than about 6.5 V.

The output of the IC is shunted by a simple LC filter formed by L1, C3 and D2.

The oscillator on board the IC generates a clock frequency of around 65 kHz and drives the output transistor via two NOR gates. The built-in error detector, the 'battery low' indicator or the voltage comparator can block the clock frequency, which causes the transistor to switch off.

The IC compares the output voltage of 5 V with a built-in reference (FET). Depending on the load, the FET will be switched on for longer or shorter periods. The maximum current through the FET is 375 mA, corresponding to a maximum output current of 80 mA.

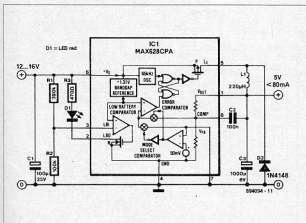

2-METRE TRANSMITTER

The transmitter was designed primarily for use by radio amateurs as a radio beacon and as such it provides a good quality signal free of unwanted harmonics.

Transistor T1, in association with crystal X1, operates as a 36

MHz oscillator. Filter L1-C3 obviates any tendency of the circuit to oscillate at 12 MHz (the fundamental frequency of the crystal).

Circuit L2-C4 is tuned to the fourth harmonic of the oscillator signal (=144 MHz). This signal is fed to the aerial via a buffer stage consisting of T2, a double-gated FET. The (amplitude) modulating signal is applied to the second gate of the buffer. The output power of the transmitter has been kept low, about 10–40 mW.

The modulating signal is generated by N1, an oscillator that switches the transmitter on and off via transistor T3. The switching rate lies between 0.1 Hz and 0.5 Hz.

When the output of N1 is low, T3 is switched off, and the transmitter is inoperative because the supply is disabled. When the output of N1 is high, T3 is on and the transmitter operates normally.

The digital pattern at the gate of T2 shapes the modulating signal. Gate N2 generates a square wave at a frequency of 0.1–1 Hz. As long as the output of T3 is high, N4 oscillates at a frequency of about 1 kHz. At the relevant gate of N2 there is, therefore, a periodic burst-signal at a frequency of 1 kHz, and this signal is used to modulate the transmitter.

The digital pattern at the relevant gate of T2 may be varied to individual requirements by altering the values of the feedback resistors in the digital chain.

The transmitter is calibrated by setting trimmers C4, C7 and C8 for maximum output power.

Inductors L2 and L3 are wound from 0.8 mm dia enamelled copper wire: L2 = 5 turns with a tap at 1 turn from ground; L3a = 3 turns and L3b = 2 turns. The coupling between L3a and L3b should be arranged for maximum output power.

The circuit draws a current of only 20 mA, enabling the transmitter to be operated from a 9-V PP3 battery for several hours.

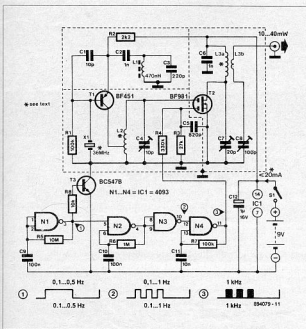

METER-SCALE MAGNIFIER

The resolution of moving-coil meters is generally no better than 1%, because the scale normally is given no more than 100 marker lines for the given dimensions: more lines might detract from the legibility. Most digital meters have a resolution of 0.05% or better. The resolution of moving-coil instruments may be improved in two ways: physically enlarging the scale, which is possible only in the factory, or electronically enlarging the scale, which is what this article is all about.

The circuit divides the scale into five sections, each of which is then extended over the full scale. This therefore gives a five-fold improvement in resolution.

The input signal (200 mV = full-scale deflection - f.s.d.) is amplified by IC1 to a value of 2.5 V. The amplified signal is fed to four comparators that divide the input signal into segments of 40 mV. Which segment is indicated on the meter-scale is shown by the LEDs.

The LEDs are shunted by a 10 k Ω resistor, so that the open-collector outputs of the comparators have a well-defined pull-up resistance.

The outputs of the comparators drive two multipliers that, depending on the magnitude of the input signal, provide a direct voltage to buffer IC2. This direct voltage is always a multiple of 0.5 V (since the output of IC1 is $5 \times 0.5 = 2.5$ V).

There then exists a potential between A and B that is equal to the difference between the input signal and a multiple of 0.5 V. This difference can never exceed 0.5 V over the f.s.d. of the meter. Resistor R4 must therefore have a value that causes a f.s.d. at 0.5 V. The measured value is determined by adding the meter reading to the multiple of 0.5 V indicated by the LEDs.

The circuit is calibrated by first setting the meter to zero reading by P2. Next, apply a voltage equal to one fifth of the f.s.d. (here, 40 mV) to the input. Then, set P3 for minimum resistance, when none of the LEDs should light. Next, set P1 for f.s.d. Finally, adjust P3 until D7 begins to light and the meter reading falls to zero.

(R. Shankar)

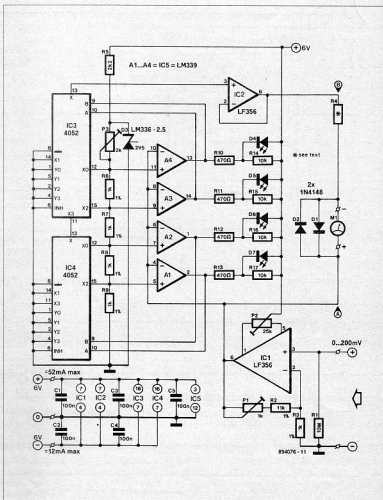

SOUND LEVEL ATTENUATOR

When the radio or record player is on at a fairly high volume, it is often impossible to hear the telephone or doorbell. A solution to this frequent difficulty is offered by this automatic attenuator. As soon as the doorbell or the telephone rings, it turns down the volume of the audio equipment.

The circuit consists of an optically controlled attenuator and the requisite electronics to connect it to, say, the telephone.

The attenuator is of fairly simple design and is based on a TL074. Its control part, consisting of a current-driven attenuator based on an LT2001 (a combination of an LED and two light-

dependent resistors - LDRs - in a common enclosure), is incorporated in the audio equipment.

After the mains has been switched on, C9 causes the resetting of bistable IC1. The high voltage level at pin 6 of the 741 causes T1 and T2 to switch off; this, in turn, results in D2 not conducting and the voltage-controlled current source, T3, delivering maximum current (30 mA) to the LED incorporated in the LT2001. The illuminated LDRs will then have a value of about 1.5 k Ω . The voltage transfer of the attenuators can be preset (once and for all) to exactly 0 dB (at 1 kHz) by P1 and P2.

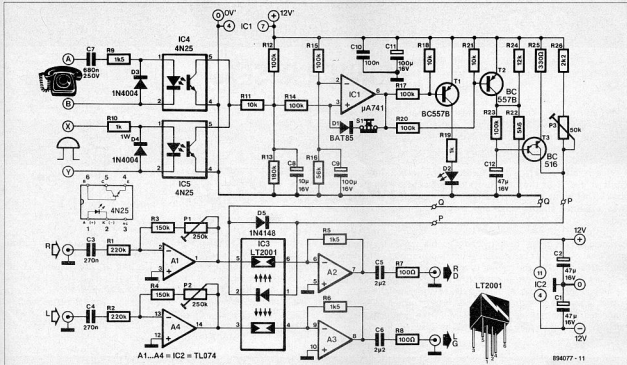

Terminals A and B of the circuit are connected direct to the corresponding terminals of the telephone (this may not be allowed in some countries – seek the advice of your local telephone manager), while terminals X and Y are connected across the doorbell terminals. Note that the doorbell must be fed from a 3–24 V transformer. If the telephone or the doorbell rings, the bistable will be set via the relevant opto-isolator (IC4 or IC5).

The low voltage level at the output of IC1 will cause T1 and T2 to switch on. This in turn causes D2 to light and C12 to charge via R23. Owing to the rising potential across the capacitor, the output of the current source will slowly diminish until the minimum value, set by P3, is reached. This has the effect that the TL074 turns down the volume click-free until a reasonable sound level,

determined by the setting of P3, is reached.

Pressing switch S1 resets the bistable. This will cause D2 to go out, while the attenuation slowly drops to 0 dB. The attenuator is connected to the control electronics by two wires, P and Q. Thanks to the current drive, this (non-shielded) link may be up to 23 metres (75 ft) long.

The attenuator draws a current of only 10 mA and must be fed from a symmetric ± 12 V supply, which may be taken from the audio amplifier. The control circuit needs an asymmetric $+12$ V supply and draws a current of about 35 mA.

If the LT2001 is difficult to obtain, discrete components may be used: these should, of course, be fitted in a light-tight enclosure.

031

COMPONENTS

FAST UNITY GAIN OPAMP

A number of operational amplifiers can be used only in circuits that have a certain minimum amplification, because they have been designed with small internal compensation. The advantage of that is that the amplifier is faster.

If we look at two popular opamps, the LF356 and LF357, these characteristics are well illustrated. The LF356 may be used as a unity-gain amplifier with a gain-bandwidth product of 5 MHz and a slew rate of $12 \text{ V}/\mu\text{s}$. The LF357 needs an amplification of not less than 5 and has a gain-bandwidth product of 20 MHz and a slew rate of $50 \text{ V}/\mu\text{s}$.

It is possible to use the LF357 (and similar opamps) with smaller amplifications by using external compensation, yet retaining most of the bandwidth. Normally, this is achieved with a capacitor, but that is not the only, and certainly

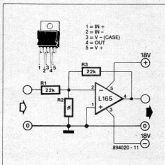

not the best, method.

An alternative method is illustrated in the diagram. Consider the L165 as a summing amplifier of which one input is connected to earth. It is clear that the second input then forms the input of a unity-gain amplifier whose amplification is determined by R1 and R3 ($R3/R1 = 1$). The unused input would have provided an amplification of 22 ($R3/R2 = 22$), which is rather more than the permissible minimum amplification of the L165. The opamp 'believes' that the amplification is higher than required. This has the benefit that the circuit has no tendency whatsoever to oscillate.

The ratio $R3/R2$ is only of value if R1 is very much larger than R2. Otherwise the amplification is $R3/(R1/R2)$.

Note that the L165 must be fitted on a good heat sink, in spite of its internal thermal overload protection (Iout max. = 3 A).

PRINTER RESET

When during a computer print-out something goes wrong with the printer, such as the paper getting snarled up, the only way to stop the operation is normally to switch the machine off. That may be a useful, but certainly not an elegant, method: a reset knob, on the other hand, is.

Nearly all printers with a Centronics interface have a reset input at pin 31 of the Centronics connector (consult the handbook). That input is used in many MS-DOS systems to set the printer to a defined starting state and at the same time to empty the buffer.

The input may, of course, also be used to connect a reset switch to. The diagram in Fig. 1a shows how such a switch may be made quite easily. The 1 k Ω resistor prevents the computer output being short-circuited when the printer is being reset.

Users of the recently published printer buffer (Ref. 1) can fit the switch in the buffer or expand the existing switch so that the printer is reset at the same time as the printer buffer. The circuit is connected to the unused contact of S1 in the printer buffer. The existing reset switch may be expanded as shown in Fig. 1b.

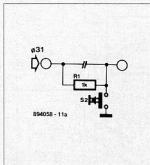

Fig. 1a

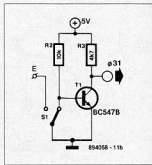

Fig. 1b

Ref. 1. 'Centronics-compatible printer buffer' *Elektron India* April 1989 p. 4-33

VARIABLE LOW-PASS FILTER

The Type SSM2045 IC from PMI is an active low-pass filter whose order, Q-factor, cut-off frequency and amplification are set with the aid of control signals.

A possible design for use in electronic music systems is shown in the diagram. To prevent distortion, the level of the input signal is reduced by R1 and a resistor on board the chip to one not exceeding 150 V peak to peak.

Outputs 2 POLE and 4 POLE are each connected to an internal voltage-controlled amplifier (VCA), MIX1 and MIX2 respectively. For optimum off-set and control rejection, these connections are made via resistors R4 and R5. The gain of the VCAs is set by P2, which controls the current that flows through the amplifiers via pins 15 and 16. The maximum current at these control inputs is 250 μ A. The balance between the VCAs, and with it the order of the filter, is set by P4 via pin 14. The voltage at this control input can be varied between -250 mV and +250 mV. The input must be driven from an impedance not exceeding 200 Ω . At a drive voltage of 0 mV, the VCAs attenuate the signal by about 6 dB.

The Q-factor depends on the current flowing into pin 17, which is controlled by P1. The input is protected by an internal 18 k Ω resistor. The Q-factor may be set so high as to cause the circuit to start oscillating. This happens when the current is between 120 and 185 μ A.

The cut-off frequency can be shifted between 20 Hz and 20 kHz by varying the control voltage at pin 5 between +90 mV and -90 mV by P3. This voltage also determines the frequency of oscillation, enabling a variable oscillator to be created. The resulting sine wave has a distortion of about 1%.

The values of C1-C4 have been chosen to give the

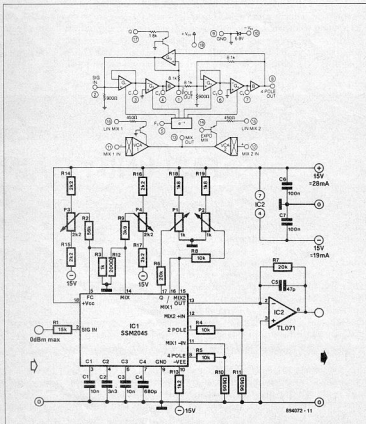

filter a Butterworth characteristic if the current into pin 17 (Q) is zero.

The supply to the IC may be -5 V connected direct to pin 10, or up to -15 V via series resistor R13, through which a current of about 7.1 mA flows. The supply, $-V_{ee}$, is limited internally by a 6.8 V zener diode.

The output current of the chip is converted into a voltage by IC2. The output of this stage has a small off-set voltage. If this can

not be tolerated by the following equipment, the output must be taken via a coupling capacitor.

In the proposed circuit, the values of resistors R2, R6, R8, R9 and R12 have been chosen to allow control of the IC from voltages of $0-5\text{ V}$ or $\pm 5\text{ V}$.

At an input signal of 0 dBm , the distortion is about 1% , which drops to 0.3% at -6 dBm and 0.03% at -20 dBm . The signal-to-noise ratio is of the order of 80 dB .

034

GENERAL INTEREST

AUTOMATIC SWITCH

Many battery-operated instruments, such as digital voltmeters, have a change-over on-off switch. The automatic switch presented here makes full use of that. When the instrument is off, C1 charges fairly quickly via R2 and D1. As soon as the instrument is switched on, C1 discharges slowly via R1. As long as the discharge current exceeds a certain level, T1 is switched on by the voltage across R1 and the supply to the instrument is on. When, after a few minutes, C1 is almost completely discharged, T1 toggles and the supply to the instrument is switched off. The period between switch-on and switch-off may, of course, be varied by different values of C1.

(Ph. Bosma)

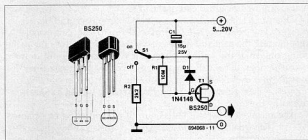

035

POWER SUPPLIES

LOW DISSIPATION REGULATOR

With the advent of the now well-known three-pin voltage regulators, power supplies are taken for granted. Yet, there are cases where such a regulator is not wholly satisfactory. This type of regulator needs a fairly large potential drop across it (typically not less than 3 V) and draws a relatively high quiescent current (typically 6 mA for a 78xx). The regulator presented here is particularly attractive for battery-operated equipments and offers:

- variable, very stable output voltage;
- low potential drop (some tenths of a volt);
- very small quiescent current ($20-30\text{ }\mu\text{A}$).

In principle, the regulator is a normal series type. The voltage reference is obtained from a common or garden red LED that must draw not less, nor much more, than $5\text{ }\mu\text{A}$. Even at that low current, an LED has a fairly stable voltage drop. To improve that stability, the current is drawn from the regulated output via R1.

Regulation is provided by CMOS opamp Type TLC271. This amplifier operates in the low bias mode, which ensures very low current consumption, by connecting pin 8 to the positive output terminal. The output of the opamp is used as base drive for series regulator T2 via current source T1. This configuration enables good control for only a small voltage swing at the output of the opamp. This is necessary since the slew rate of the opamp in the low-bias mode is pretty poor. The supply for the opamp is also taken from the regulator output. Capacitor C1 therefore serves as decoupling element for the opamp.

To obtain reliable control, a kind of bootstrap resistor, R5, was found necessary.

The values of R1 and R4 as shown in the diagram provide a variable output voltage of $3-8\text{ V}$. Higher output voltages, up to a maximum of 16 V , are obtained by increasing R4 by $200\text{ k}\Omega/\text{V}$. Resistor R1 should also be increased in value, as long as the current through D1 does not drop below $5\text{ }\mu\text{A}$.

In this type of circuit, great care should be taken to avoid parasitic capacitances resulting from long connections. These would cause a deterioration of the regulation.

The maximum output current depends mainly on the permissible dissipation in T2 and, therefore, to some extent on the difference between the input and output voltage.

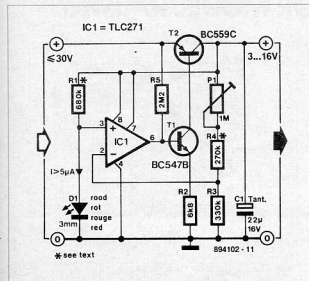

DUPLEX AUDIO LINK

Duplex communication is, of course, not a new technique: it has been used, for instance, in telephone systems for many years. Those systems, however, make use of transformers to achieve duplex – the circuit presented here does it with the aid of electronics. The principle is fairly simple. Two senders impose signals U_1 and U_2 respectively on to the audio cable. The voltage across the cable is then $(U_1+U_2)/2$. The receivers at both sides of the cable deduct their side's sender signal from the cable signal: the result is the signal sent from the other end of the cable. This principle is the basis of the circuit shown. Note that a circuit like that is required at either end of the link.

Opamp A1 is connected as a buffer amplifier and serves as sender. The send signal is imposed on to the cable via R4. Terminating the cable by R4 results in the voltage across the cable being only half the voltage output of A1. This does not detract from the operation of the circuit, however. At the same time, R4 ensures that signals emanating from the other end of the link can not get to the output of A1; if they could, they would be short-circuited by the output.

The receiver is a differential amplifier consisting of opamps A2–A4. The quality of the differential amplifier depends largely on the resistors used in association with the opamps and 1% types are, therefore, essential.

The cable signal, $(U_1+U_2)/2$, is applied to one input of the differential amplifier and the (halved) output signal of A1 to the other. Since the differential amplifier has a gain of 6 dB, the received signal applied to K2 has the same level as the original signal.

In practice, the proposed duplex system is not perfect and it is for that reason that, for instance, remnants of the sent signal are detectable in the receiver. Fortunately, these can be removed with the aid of P1. Furthermore, the cable used will load the output slightly capacitively, which causes the compensation voltage at the wiper of P1 to be not wholly in phase with the sent signal.

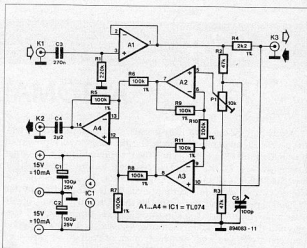

This effect may be virtually removed with the aid of C1.

The circuit is calibrated by connecting the cable to it and to its twin circuit and injecting a sinusoidal signal at a frequency of 1 kHz and a level of 5 V rms to its input. The input bus of the other circuit must be short-circuited during the calibration. Adjust P2 for minimum signal at K2. Next, increase the frequency of the input signal to 10 kHz and adjust C5 for minimum signal at K2. Repeat the procedure with the other circuit.

The signal suppression at 1 kHz is of the order of 80 dB, while at 20 kHz it is around 60 dB. These are pretty good values for this kind of circuit.

HEAD / TAIL LIGHTS FOR MODEL RAILWAY

The price of a model railway locomotive is directly proportional to its facilities and finish. There are quite a few inexpensive ones on the market of which the finish leaves a lot to be desired. As a rule, manufacturers start their economy with the lights. The circuit presented here enables a DC locomotive to be provided with direction-independent head and tail lights. Since it uses LEDs, a very long life is guaranteed.

The circuit is based on a number of parallel-connected LEDs in a bridge network. The FET at the centre of the bridge ensures a constant current as long as the supply voltage exceeds 4.5 V. The brightness of the lights will, therefore, be independent of the supply voltage.

The LEDs are connected in parallel to keep the minimum operating voltage as low as possible. To ensure good current distribution, the pairs of parallel-connected LEDs should be of the same type and colour.

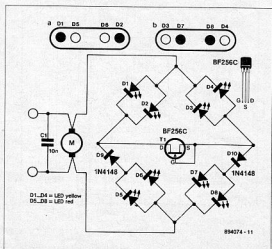

I/O-FRIENDLY KEYBOARD

Not all computers have a keyboard, yet it is often essential to have the use of one. Two circuits are presented here that enable a keyboard facility to be produced with the aid of only six or seven I/O lines.

Fig. 1 shows a circuit based on a 74HCT148 and a 74HCT138 that can serve 56 or 64 keys. The circuit in Fig. 2, based on a 74HCT147 and a 74HCT138, can address 72 keys via seven I/O lines. The choice between the two circuits depends on the number of available I/O lines and the wanted number of keys.

In either circuit, the key rows are selected by the bits on the A, B or C input of the HCT138. The combination of these bits deter-

mines which of the outputs Y0-Y7 goes low. As long as no key is depressed, the inputs of the HCT148 in Fig. 1 or the HCT147 in Fig. 2 are high. When a key is pressed, the inverted binary information at the output of the ics show which key it is.

In Fig. 1, the 0 input of the HCT148 is not used, because the code associated with that input is the same as that generated when no key is pressed. The output, pin 14, of this ic is used to detect whether a key has been pressed. It goes low when a key has been pressed.

In Fig. 2, four 1s at the output indicate that no key has been pressed.

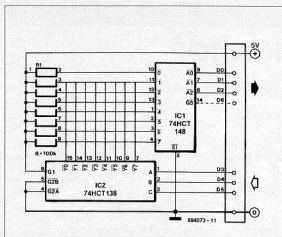

Fig. 1.

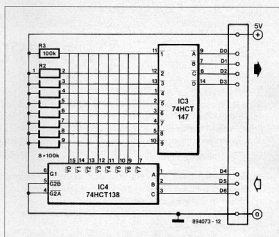
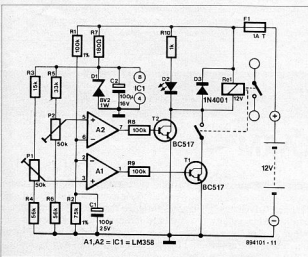

Fig. 2.

ENERGY CONTROL FOR BATTERY CHARGERS



In most automatic battery chargers, the power transformer remains connected to the mains even after the battery (or batteries) has been charged. In many cases, considerable energy savings can be achieved by disconnecting the transformer from the mains when the battery is fully charged. This circuit performs this function for 12 V car battery chargers.

The battery voltage is monitored by an adjustable window comparator around opamps A1 and A2, which are powered by a stabilized supply voltage of 8.2 V (R7-D1). The high and low switching thresholds, U_{H1} and U_{L1} , are set by presets P1 and P2 respectively. The reference voltage for the opamp is obtained from junction R1-R2 and is a function of the battery voltage. With the given values of R1 and R2, a voltage divide factor, D, is obtained

$$D = R2 / [R1 + R2] = 0.43.$$

Taking into account the series resistors connected to the presets and the use of an 8.2 V supply voltage, the span of P1 is

$$7.2 / D = 16.7 \text{ V (max)} \text{ to } 3.8 / D = 8.9 \text{ V (min)}$$

and that of P2 is

$$6.3 / D = 14.5 \text{ V (max)} \text{ to } 3.3 / D = 7.7 \text{ V (min)}$$

In practice, it will be desirable to switch the charger off at a battery voltage of 14.0 V and on again when the voltage drops below 12.5 V, corresponding to a window of 1.5 V.

When the battery voltage is lower than U_L , it is, of course, also lower than U_H . This means that both T1 and T2 conduct, so that Re1 is energized. Contact K2 switches on the mains to the battery charger, and contact K1 keeps the relay energized even when T2 is switched off and the battery voltage rises to a value between U_L and U_H . When the battery voltage reaches U_H , both T1 and T2 are turned off, so that the relay is de-energized. After a while, however, it will be switched on again because the battery voltage will

have dropped a little owing to the drop across its internal resistance.

Assuming that the required switching levels are $U_L = 12.5 \text{ V}$ and $U_H = 14.0 \text{ V}$, the presets are adjusted as follows. Disconnect C1 and set P1 for U_H (max) and P2 for U_L (min). Power the circuit from a regulated supply set to 12.5 V and adjust P2 until the relay is just energized. Then increase the supply voltage to 14.0 V and adjust P1 until the relay is just de-energized. Finally, connect C1 again and connect the circuit to the battery terminals.

The relay must be rated at 12 V DC and 300 Ω . It must have two make or change-over contacts, of which at least one has a voltage rating higher than the mains voltage. One suggested type is the V23037-A2-A101 from Siemens.

The circuit draws 25 mA, which rises to 65 mA when the relay is energized.

(M.S. Dhingra)

040

TEST & MEASUREMENT

TTL SUPPLY MONITOR

The Type LTC1042 IC from Linear Technology is a window comparator that can function with very small currents. This is made possible by the use of sampling techniques that enable the disabling of certain parts of the IC in the non-active phase. This economical behaviour is not so important in the present circuit: the monitor draws a current of rather more than the minimum 100 μA .

The comparator is set with the aid of a bandgap reference diode, D1. The reference voltage of 2.5 V provided by this diode is connected direct to the window centre pin 2.

The width of the window is also fixed with the aid of the reference voltage. Since the circuit is intended to monitor a TTL supply (5 V), the width of the window is arranged at one tenth of this, which is a convenient sub-multiple of the reference voltage. Potential divider R4-R5 gives a voltage of 0.25 V at half-window-width pin 5. This arrangement causes the within window output to go high when the input voltage (V_{in} at pin 3) exceeds $2.5 \text{ V} \pm 10\%$. The input voltage is held at exactly half the supply voltage by potential divider R1-R2.

Transistors T1 and T2 drive indicator LEDs. When D2 lights, the circuit and the supply voltage are all right. When D3 lights, the supply voltage is too high. If neither of the diodes lights, the supply voltage is too low or even absent.

If you want a LED to indicate that the supply voltage is too low, interchange the function of pins 2 and 3. The above window output then becomes a below window output. Note that the circuit then needs a separate power supply, otherwise the below window LED can not be actuated.

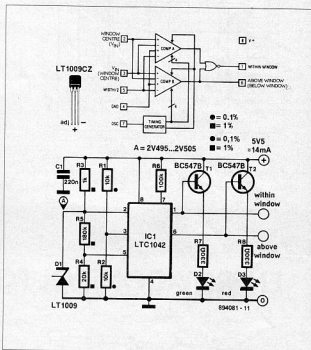

041

CAR ELECTRONICS

CAR ALARM

The car alarm accepts signals from a variety of sources, including special sensors and the standard switches in a car, such as the door and ignition contacts. The unit has a relay output that enables controlling an acoustic transponder (loudspeaker, buzzer), light, a radio transmitter, and others.

The alarm is remarkably simple to set, because all control func-

tions are performed by a single switch. It is switched on after parking the car by closing S1 when the green LED lights to indicate that the driver has 13 seconds to leave the car. When this delay has lapsed, a yellow LED lights to indicate that the alarm is set. When any of the alarm sensors is actuated (which also happens when the rightful owner of the car opens a door), a red LED lights.

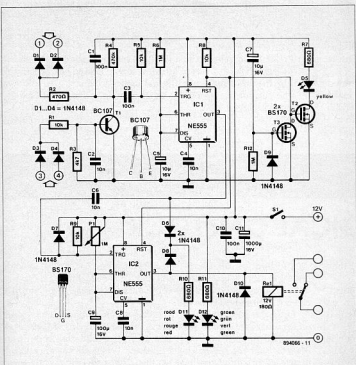

The relay will then be energized after 17 seconds unless switch S1 is opened in the mean time. Since the location of that switch is known only to the car owner, anyone entering the car illegally will set off the alarm.

Two timers Type NE555 are connected as monostable multi-

brators. Transistor T1 and associated components form the triggering stage, which is sensitive to both positive and negative triggering signals supplied by the sensors or switches. MOSFETS T2 and T3 serve to provide the 'delayed disable' function and to drive the 'alert' LED respectively.

When the unit is powered, D12 lights, but the alarm remains off for the time defined by time constant R12-C7. Since the capacitor is initially discharged, T3 conducts and pulls the reset pins of both timers to ground until the voltage across R12 has dropped to about 3 V. That level enables both timers, and causes the 'alert' LED to light. When the power is switched off for a second and then on again, C7 is discharged rapidly via D9; this sequence resets the alarm to its initial state.

When enabled, the alarm may be actuated by a low level at input pins 11 or 12 (door switches) or a high level applied to inputs 13 or 14 (ignition system power). The number of inputs may be expanded as required by adding one diode for each sensor or switch. When only one of the inputs is used, it is still recommended to use a diode.

Any trigger pulse or change in the direct voltage at the inputs triggers timer IC1 via C3 and C5. The output pin, 3, of IC1 is driven high so that the 'actuated' LED (D11) lights. Diodes D6 and D8 form an OR function to decouple the outputs of the timers. Capacitor C6 is discharged in preparation of the triggering of IC2. After the delay set by R6-C5, the output of IC1 goes low, thereby triggering IC2 via R9 and C6. The output relay is energized and the transponder is powered by the car battery

via the relay contact. The alarm sounds for about 65 seconds (defined by R9-C10). The unit may be reset at any time, however, by operating S1 for at least a second.

(R. Lalic)

042

GENERAL INTEREST

TWILIGHT SWITCH

This inexpensive unit switches the light on at dusk and off again at dawn. The circuit has separate time bases for the on and off delays. The dotted line in the diagram divides the circuit into two halves: A, the light-dependent switch around gate N1; and B, the on-off time base around N2 and LED and relay driver T1-T2.

The voltage at junction R2-R9-C1 is inversely proportional to the light intensity measured by light-dependent resistor (LDR) R9. Schmitt trigger gate N1 toggles whenever this voltage reaches one

of the input threshold levels. Since the difference between these levels is large compared with the voltage span produced by the potential divider, a variable feedback loop is provided to achieve an effective switching span of 300 to 400 mV. When the output of N1 is high, the voltage at junction R1-P1 is almost equal to the supply voltage. When the output is low, the voltage drops to the level required for the threshold difference at the input of N1.

The output of N1 drives two time base circuits: C2-R4-D1 for the 'on' state and C2-R5-D2 for the 'off' state. These networks switch the output of N2 on and off after the wanted delays. The lamp relay and an indication LED are driven by darlington stage T1-T2, which is controlled by the output of N2.

Capacitor C1 prevents HF signals picked up by the cable between the LDR and the switching unit causing spurious triggering. Because of the high output impedance of the Type 4093, the cable should be a screened type.

The remaining two gates in

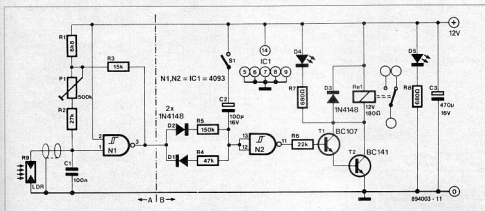

the 4093 package may be used for duplicating the time base (part B) to obtain a switching sequence. The values shown for R5-C2 and R4-C2 form a good starting point for dimensioning the delays introduced in this additional time base. The lowest permissible value of R4 and R5 is 47 k Ω : their highest value depends mainly on the leakage current of C2.

During the testing of prototypes of this circuit it was noted that the switching threshold and hysteresis depend on the make of the 4093. Good results were obtained with SGS's HCF4093BE; devices from other manufacturers may require the value of R3 to

be slightly different. The inputs of the unused gates in the 4093 must be earthed.

The LDR is mounted in a suitable waterproof housing, screened from direct light sources.

Preset P1 serves to adjust the light intensity level at which the circuit switches. To prevent too slow a response to changes in the setting, the timer should be aligned with S1 open.

The current drawn by the timer is mainly that drawn by the energized relay.

(R. Lalic)

043

CAR ELECTRONICS

PSYCHOLOGICAL CAR LOCK

The lock circuit is based on elementary psychology rather than on any recent development in electronics.

The lock consists of a 12-key membrane keypad and an associated visual indication circuit. The complete unit is installed in an out-of-the-way position below the dashboard in a car, where it is not too difficult for a potential car thief to spot.

When the keys on the keypad are pressed, the impression is given that the lock will enable the car ignition when all four LEDs light. Because of the special configuration of the lock circuit, this will never happen. Eventually, the would-be thief gets frustrated (we hope) and tries another car, not realizing that the lock circuit is simply not connected to the ignition circuit. Only the rightful owner knows that the car can be started after a special switch, marked, say, 'wiper' is operated. This switch, installed as an accessory on the dashboard, is connected in series with the positive supply line to the ignition coil.

The membrane board must be a type with a common line, not one with a matrix configuration. A suitable keyboard may, of course, also be made from individual keys with numbered caps. The lines marked K0-K9 in the diagram must go to the associated key number on the keypad. Keys * and # are non-connected dummies. The four LEDs are fitted in a row near the keypad, and give an indication that suggests that the combination entered is correct.

As already stated, the circuit makes it impossible for all four

LEDs to light simultaneously. This is because pin 3 of N1 is logic high when D1 is on. This means that T5 is off, so that D4 can not light in spite of all other key combinations. It also means that D4 can not light unless D1 is out.

Eight XOR gates in two 4070 packages determine which LEDs are on for a particular code entered via the keyboard. RC networks connected to each keyboard line keep this active for about four seconds after the key has been released. When, for instance, key 1 is pressed briefly, the voltage on line K1 rises to the supply level. Since pin 13 of gate N8 is then the only logic high input of all XOR gates, pin 4 of N2 goes high. This causes T2 to conduct and D2 to light. After about 4 s, the voltage on C1 has dropped to a level that N8 recognizes as logic low, and D2 goes out. Within the 4 s period it will, however, go out the instant key 5 or 7 is pressed. Diode D3 then lights, followed by D2, which remains on for a short period. The two LEDs then go out simultaneously. Note that this functional description applies to only one of many possible combinations.

Apart from its use in cars, the circuit may also find application in games.

The current drawn by the circuit is mainly that drawn by the LEDs that are on during the 4 s interval. In stand-by mode, less than 1 mA is drawn.

(C. Sanjay)

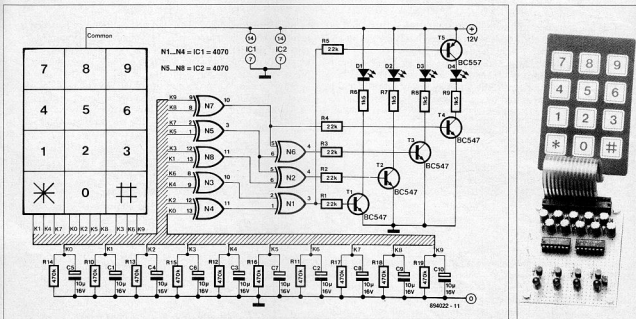

X-Y PLOTTER INTERFACE

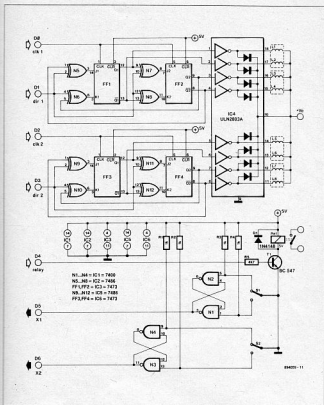

This low-cost circuit can drive two stepper motors and a relay by digital control data supplied from a computer. It can also detect the position of two microswitches and supplies logic levels back to the computer as positional information. This combination makes the interface ideal for use as an X-Y plotter or for building a buggy-style robot.

Circuit IC1 is configured as two set-reset (S-R) latches to provide contact debouncing for the two microswitches, S1 and S2, whose position is detected by computer reading port bits D5 and D6. The relay drive circuit around T1 may be used to switch a solenoid-operated pen on and off under the control of port bit 4.

Motor drive is provided by XOR gates N5-N12, bistables FF1-FF4 and integrated motor coil driver IC3. This combination can drive two unipolar 4-phase stepper motors in half-step mode by setting the direction of rotation with the aid of bits D1 and D3, and a high-to-low logic pulse transition on bit D0 or D2. The control functions are summarized in the table. The motor driver, IC4, is capable of sourcing 500 mA per phase at a maximum motor voltage of 50 V. The ULN2803A has internal diodes that protect it against reverse EMF generated by the motor coils when they are deactuated.

To drive the interface from a computer, set the I/O port for five output bits, D0-D4, and two input bits, D5 and D6, and send the appropriate control signals to the circuit.

The interface requires two supply voltages: 5 V for the logic circuits and the relay driver, and 12 V (+Ve) for the stepper motor coils. Motor 1 is L1-L4 and motor 2 is L5-L8.

Step pulse	Motor 1				Motor 2			
	L1	L2	L3	L4	L5	L6	L7	L8
0	1	0	1	0	1	0	1	0
1	1	0	0	1	0	1	1	0
2	0	1	0	1	0	1	0	1
3	0	1	1	0	1	0	0	1
0	1	0	1	0	1	0	1	0

TIMER WITH AUDIBLE WARNING

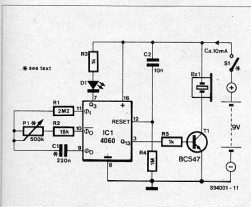

Applications of this little circuit include a portable parking meter timer and egg timer. The 14-stage binary ripple counter Type 4060, IC1, has an on-chip oscillator capable of stable operation over a relatively wide frequency range. In the present circuit, the oscillator frequency is determined by an external RC network connected to pins 9, 10 and 11.

When the circuit is switched on with S1, the pulse at junction R4-C2 resets the counter and counting starts. When the count reaches bit 14 (Q13), pin 3 goes high so that the self-oscillating piezo-electric buzzer, a 12 V type, is turned on via driver T1.

The time delay is set with the aid of P1. Time delays of between one minute and two hours are possible by appropriate dimensioning of the timing components:

- 1-30 minutes: C1 = 220 nF; P1 = 500 kΩ
- 1-60 minutes: C1 = 470 nF; P1 = 500 kΩ
- 1-120 minutes: C1 = 470 nF; P1 = 1 MΩ

The timer is powered by a 9 V PP3 battery. Light-emitting diode D1 does not affect the operation of the circuit and is included merely to show that the timer works. Diode D1 and resistor R3 are, therefore, optional components. A mercury tilt switch may be used for S1 if the unit is to be used as a kitchen timer. The timer is

then started by inverting it like a sand-glass.

With the buzzer actuated, the timer draws a current of about 10 mA.

(R.G. Evans)

046

TEST & MEASUREMENT

HCMOS SQUARE WAVE GENERATOR

This pulse generator supplies three rectangular output signals with a duty factor of 0.5. The signals have a fixed phase relation to one another: output 3 is the reference; output 2 has a phase shift of about 180°; and output 1 has a phase shift of about 10°.

The generator is formed by the four bi-directional HCMOS electronic switches contained in a Type 74HC4066 IC. Its operation is based on the fairly accurately defined switching threshold of an HCMOS input. The toggle point for low and high levels lies around $U_b/2$ to ensure a duty factor of 0.5 and thus a square wave output signal.

When the supply is switched on, C1 is charged via R3 and the on-resistance of ES3. When the voltage of C1 reaches $U_b/2$, ES4 closes and pulls the control input of ES3 low, causing C1 to discharge via ES2 and R3. When the 'low' switching threshold is reached at the control input of ES4, the generator starts to oscillate.

Considering the oscillator is basically an RC type, its stability is pretty good.

The output frequency of the generator is a function of the control voltage, U_c , as shown by the accompanying characteristic.

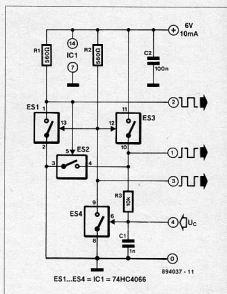
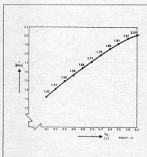

047

POWER SUPPLIES

HIGH-POWER ZENER DIODE

Although its regulation characteristics are not as good as those of an integrated voltage regulator, a high-power zener diode has, nevertheless, useful applications, for instance, in shunt regulators.

The circuit shown in the diagram simulates a fairly expensive and hard-to-come-by high-power zener diode. Basically a two-stage current amplifier with a low-power (400 mW) zener reference, it is capable of sinking up to 500 mA at a maximum 25 V. The effective zener voltage of the circuit is about 0.7 V higher than that of the reference device, D1.

Using a preset, P1, instead of a fixed resistor, R1, enables the output voltage defined by D1 to be increased slightly. This substitution is useful when, say, a 6V2 or 9V1 zener is to be simulated and a low-power type of this rating is not available. The next lower value in the E6 range (here, 5V6 or 8V2) may then be used for D1.

When the voltage across the circuit increases beyond the zener voltage, T1 conducts and provides a base current to T2. This power transistor then passes virtually all the current the 'zener' is capable of sinking. The dimensions of the heat sink for T2 depend on the maximum expected dissipation.

Transistor T1 should be a PNP type with a fairly high current

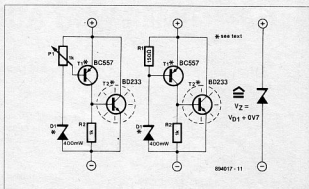

gain, for instance a BC557B or BC559C, while T2 may be almost any medium or high-power NPN type, for example, a BD135 through BD139, BD241, TIP31 or 2N3055.

(C. Sanjay)

VOLTAGE-CONTROLLED OSCILLATOR

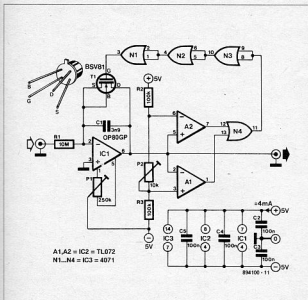

The voltage-controlled oscillator (VCO) presented here is based on a Type OP80 operational amplifier. This opamp has an exceptionally low bias current of, typically, about 200 fA (femto-ampere is 10^{-15} amp) and 2 pA maximum, so that any off-set caused by this current is minute. It is, therefore, ideal for use as an integrator, because the operation of that kind of circuit is affected readily by off-sets.

The OP80-based integrator in the diagram is used as a VCO that is not affected by the polarity of the control voltage. A direct voltage at the input of the circuit will cause C1 to charge. Depending on the polarity of the input voltage, the potential across C1, and thus the output voltage of IC1, will be positive or negative. The speed with which C1 charges depends on the magnitude of the input voltage: this characteristic is used to generate a signal at a voltage-dependent frequency. To that end, the output signal of IC1 is applied to a window comparator that has a switching

threshold for both the positive and the negative maximum signal. These maxima are set to ± 100 mV by P2. In some cases, it may be advantageous for symmetry to split R2 or R3 into a fixed resistor in series with a preset potentiometer.

When one of the comparators toggles, T1 is switched on via N1-N4 so that C1 discharges. This results in a neat sawtooth signal at the output of the circuit, whose frequency depends on the input voltage. Gate N4 ensures that the FET reacts to both comparators. The other three gates delay the switching signal slightly to ensure that the FET is switched on long enough to allow C1 to discharge completely.

The Type BSV81 MOSFET is provided with a separate substrate connection that must be linked to the source. Since the substrate is already connected internally to the housing, the device is very sensitive to random radiation, so that the oscillator is best fitted in a small metal enclosure.

If a BSV81 is not obtainable, another MOSFET with very low $R_{DS(on)}$ and very small C_{pg} may be used. If that also is not possible, a junction FET may be tried, but in that case a diode must be connected in series with the gate and a resistor of about 10 k Ω between the gate and the negative supply line. It is important to ensure that the pinch-off voltage level is reached readily. It may well be necessary to experiment with the value of C1.

Correct dimensioning of R1 will enable the relation between input voltage and frequency to be set at, say, 1 Hz/mV. With the input short-circuited, adjust P1 for the lowest possible frequency of the output signal (ideally, $f = 0$). The maximum input voltage is determined by the peak output current of IC2 (15 mA) and amounts to $15 \times 10^{-3} \times R1$.

The output signal of the VCO is a clean sawtooth signal at a frequency of up to 10 kHz, although higher frequencies are possible. The frequency as a function of the input current is given by:

$$f = I_{in} / (U_{top} \times C_1) \quad [\text{Hz}].$$

With values as shown in the diagram,

$$f = I_{in} / (3.9 \times 10^{-10}) \quad [\text{Hz}].$$

Finally, note that the supply voltage to the OP80 must under no circumstances exceed ± 8 V. The circuit draws a current of typically 4 mA.

MONITORING TEMPERATURE WITH THE C64

Maplin's module Type FE33L provides an inexpensive and convenient means of monitoring temperature. The module has a built-in A-D converter and an LC display and works from a single 1.5 V battery. Since it is often impractical to take frequent readings manually, the module provides a serial data output that can be used with most microprocessor systems. The combination of hardware and software given in this article enables a C64 computer to use the serial data, within BASIC, via the USR function.

The hardware consists of nothing more than a simple TTL level board and may be mounted on a small piece of prototyping board. This may be connected to the module by three short wires, while the outputs go to a two-by-twelve 0.156" pitch edge connec-

tor for the C64's user port. Pins 5 and 16 of the module should be short-circuited to obtain the maximum sampling rate of one per second. Check all connections before switching the computer on.

The listing provided loads a machine-code program into the small section of RAM above the BASIC ROM at location 49152 (\$C000). Note that some lines are very similar to others thus assisting entry. Once this has been RUN (without errors), and SYS 49152 has been entered, the temperature is obtained as follows:

```
TEMP = USR(0) : PRINT TEMP
```

This line can be incorporated into any BASIC program.

```

0 REM *****
1 REM *** Maplin Temperature Module ***
2 REM ***   Interface Software   ***
3 REM *****
4 REM *** SYS 49152 to initialise ***
5 REM *** Temperature = USR(0) ***
9 :
10 FOR L = 0 TO 178:READ A:T-T+A
11 POKE 49152+L,A:NEXT L
12 IF T<>23290 THEN ? "Error in DATA "
13 :
14 DATA 162,0,142,3,221,169,16,141
15 DATA 17,3,169,192,141,18,3,96
16 DATA 120,169,2,162,0,44,1,221
17 DATA 208,251,172,1,221,232,44,1
18 DATA 221,240,250,224,90,48,236,162
19 DATA 13,152,41,1,157,179,192,202
20 DATA 169,2,44,1,221,208,251,173
21 DATA 1,221,41,1,157,179,192,202
22 DATA 169,2,44,1,221,240,251,224
23 DATA 0,208,229,162,13,189,179,192
24 DATA 73,255,41,1,157,179,192,202
25 DATA 208,243,160,0,32,162,179,32
26 DATA 12,188,162,12,160,4,10,24
27 DATA 125,179,192,202,136,208,247,32
28 DATA 155,192,10,24,125,179,192,202
29 DATA 136,208,247,32,155,192,10,24
30 DATA 125,179,192,202,136,208,247,168
31 DATA 32,162,179,32,106,184,32,254
32 DATA 186,173,192,192,240,3,32,180
33 DATA 191,88,96,142,191,192,168,32
34 DATA 162,179,32,106,184,32,226,186
35 DATA 32,12,188,169,0,160,4,174
36 DATA 191,192,96

```

The first part of the machine-code program sets the USR vector and all the port B lines to input, while the remaining code is called by the USR function itself. When called, the program waits for the primary clock pulse, which is longer than the others, and then reads in each subsequent bit from the data line. These bits are converted from BCD format into a single floating-point

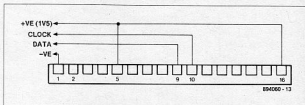
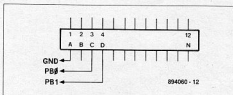
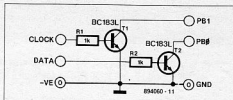

that is returned by the USR function. The software will behave correctly only when the module is in the default °C mode, but this is not a restriction as readings can be converted readily to another scale. If the device is to be used for serious control applications, it must be borne in mind that the software will wait patiently for the primary clock signal to arrive from the module. If the clock signal fails for any reason (for instance, a break in the cable), the control program will be left hanging in an endless loop. It is, therefore, recommended to use a non-maskable interrupt (NMI) generated by the timers on CIA #2 to interrupt the program after a specific duration (for example, greater than the expected sampling time) and return some sort of error condition. For simple applications, this is not necessary and no further programming is required.

(J. Pelan)

050

POWER SUPPLIES

SIMPLE VARIABLE POWER SUPPLY

This low-cost power supply has an output voltage range of 1.5–15 V at a maximum current of 500 mA. Regulation is better than 2% for output currents not exceeding 350 mA. Voltage adjustment is effected by a potentiometer and an acoustic overload indication is provided.

Transistor T4 compares the voltage at the wiper of P1 with the output voltage. When this is 0.65 V higher than the set voltage, T2 is switched on, which removes the base current from darlington power stage T3-T5. In this manner, the output voltage of the supply is 0.65 V higher than the reference potential at the base of T4, which is derived from a 15 V zener diode, D5.

The voltage at the 18 V, 1 A winding of the external mains transformer is rectified by bridge B1 and smoothed by C1. A simple acoustic overload alarm (Bz1) is actuated when the output current exceeds around 500 mA. Note that the exact level of actuation depends on the electrical specification of the buzzer, which should be a 24 V, self-oscillating type.

The power supply is, in principle, not short-circuit proof, although the use of a generous heat sink for T5 will enable that transistor to withstand the maximum dissipation of about 20 W for the few seconds that lapse before the supply is switched off.

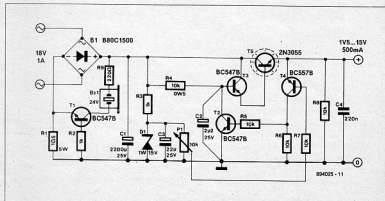

To obviate radiation, the supply must be fitted in a metal enclosure. Interconnections should be kept as short as possible.

Capacitors C2 and C3 should be tantalum types.

(P. Sicherman)

051

GENERAL INTEREST

HEATING TIMER

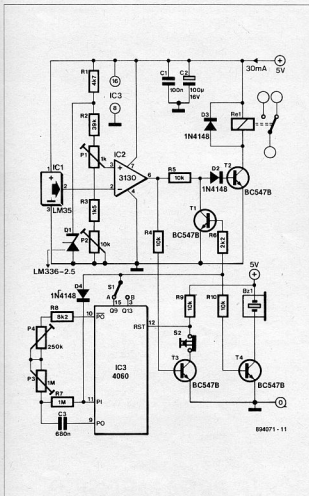

This timer has temperature and time settings. The temperature range is about 150 °C and the time delay is around 25 minutes.

The temperature controller, IC2, is driven by sensor IC1, the familiar Type LM35, which produces an output voltage of 10 mV/°C. This voltage is compared with a reference potential provided by a high-stability, temperature-compensated zener diode, D1. Presets P1 and P2 form the fine and coarse controls respectively for setting the temperature. The comparator switches on T2 whenever the temperature measured by IC1 is below the set value. This causes the relay, Re1, to be energized so that the heater element is powered via the relay contacts.

The timer function is based on oscillator/divider IC3, whose clock frequency is determined by the variable RC network between the P1 and P0 pins (9 and 11). The clock signal, divided by 2¹⁰ and 2⁴, appears at pins 15 and 3 respectively. Toggle switch S1 selects either of these outputs to give time delays of 6 s to 1.5 min. and 1.5–25 min. These settings are marked A and B respectively.

When the delay set by P3-P4 has lapsed, the oscillator in IC3 is disabled by the high level at the pole of the time selector switch. At the same time, T1 is switched on, T2 is switched off, and the (active) buzzer sounds to indicate that the set time has lapsed. The relay is de-energized via T2 and the heater is disconnected from its supply. The timer may be reset while the heater is on by pressing S2.

Some accurate calibration is required in the temperature controller. Connect a digital voltmeter between earth and junction R3-P1 and adjust P2 to obtain a voltmeter reading of 100 mV (= 10 °C). Set P1 as appropriate by actually measuring the temperatures at which the relay is energized. Next, set P3 to minimum resistance and S1 to position A and adjust P4 to obtain a time delay of 5–6 seconds after S2 has been pressed. The time delays are set by P3 with the aid of an accurate watch. This procedure is not required for position B, since in this delays 16 times as long as in position A are provided automatically. If a simple thermostat only is required, the timer circuit, T1, T3 and T4 may be omitted.

The circuit is powered by a regulated 5 V supply and draws a current of about 30 mA with the relay inoperative.

The coil resistance of the relay must be not less than 400 Ω.

The temperature sensor must be fitted, of course, at some distance from the heating element.

(C. Sanjay)

052

CAR ELECTRONICS

IMPROVED LOW FUEL INDICATOR

The indicator described here obviates the flickering of the 'low fuel' warning light on the dashboard caused by vehicle movement. The indicator ensures that the light remains extinguished until the duty factor of the signal supplied by the fuel sensor is smaller than 0.5. When that happens, the light comes on and remains on until the fuel tank has been filled to a sufficient level. The present circuit tests the light by causing it to flash for about 5

seconds every time the ignition key is turned to start the engine.

The signal processor is switched on together with the ignition. Initially, C1 is discharged, enabling oscillator N2 via inverter N1. One input of N3, pin 12, is connected to R3-C3, the time constant of which is equal to that of R1-C1. If the output of the fuel sensor is high, pin 12 of N3 is held high via R2-C3. The 1.5 Hz signal from oscillator N2 is inverted by N3 and passed to darlington

lamp driver T1-T2. After the delay introduced by R1-C1 has lapsed, gate N1 disables oscillator N2 so that the warning light goes out.

When the fuel sensor inside the fuel tank supplies pulses owing to vehicle movement, C3 is charged via R3 and discharged via R2-R3. When the duty factor (on / off ratio) of the level sensor signal drops below 0.5, the potential across C3 becomes high enough to enable the lamp driver, so that the 'fuel low' warning light is on permanently without any flicker.

(R. Lalic)

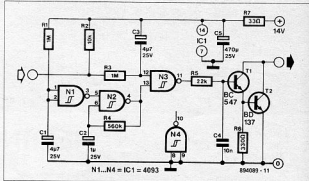

053

AUDIO & HI-FI

A SIMPLE VOX

A VOX is a voice-operated switch that is often used as a substitute for the press-to-talk switch on a microphone. The one described here can be connected to almost any audio equipment that has a socket for an external loudspeaker. The actuation threshold is set by the volume control on the AF amplifier that drives the VOX.

The (loudspeaker) signal across R2 is capacitively fed to the base of T1. Resistor R3 limits the base current of this transistor when the input voltage exceeds 600 mV. Diode D1 blocks the positive excursions of the input signal, so that U_{e-b} can not become more negative than about 0.6 V.

The output relay is driven by darlington T2. Resistor R4 keeps the relay disabled when T1 is off. The value of bipolar capacitor C2 allows it to serve as a ripple filter in conjunction with T2. Resistor R5 limits the base current of T2 to a safe level.

The switching threshold of the VOX is about 600 mV across R2. The maximum input voltage is determined by the maximum permissible dissipation of R2 and R3. As a general rule, the input voltage should not exceed 40 V (p-p).

The current drawn by the VOX is mainly the sum of the cur-

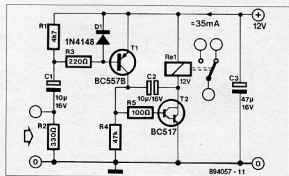

rents through the relay coil and through R5. The resistor may carry up to 100 mA when the VOX is overdriven.

(S.G. Dimitriou and F.P. Maggana)

054

AUDIO & HI-FI

LOW-NOISE MICROPHONE PREAMPLIFIER

The microphone preamplifier described is based on the SSM2015 from Precision Monolithics Inc. (PMI), which offers a very high gain and very low noise ($1.3 \text{ nV}/\sqrt{\text{Hz}}$). It is intended for use with balanced input signals and is capable of providing an amplification of 10-2,000, depending on the value of R4. With $R5 = R6 = 10 \text{ k}\Omega$, the amplification, A, is calculated from

$$A = (20,000 / R4) + 3.5$$

With values as shown in the diagram, the amplification is, therefore, about 1,000.

Resistor R3 sets the operating point of the differential input amplifier and thus determines the bandwidth and the slew rate. A value of 33 k Ω gives near-optimum values of these characteristics, but results in a relatively high input bias current of 4.5 μA (with $R3 = 150 \text{ k}\Omega$, the current is only 1 μA). Moreover, the input noise

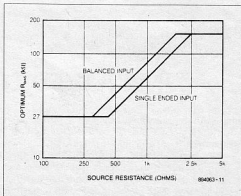

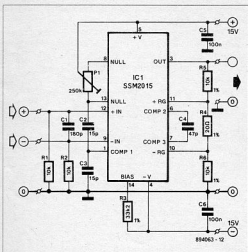
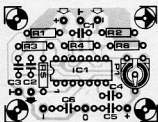
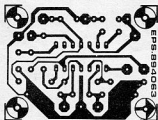

Table 1

R3	C3	C2
27-47 kΩ	15 pF	15 pF
47-68 kΩ	15 pF	10 pF
68-150 kΩ	30 pF	5 pF

Table 2

R3	27-47 kΩ	47-68 kΩ	68-150 kΩ
A = 10	P1 = 500 kΩ	250 kΩ	250 kΩ
A = 100	P1 = 500 kΩ	100 kΩ	100 kΩ
A = 1000	P1 = 250 kΩ	100 kΩ	50 kΩ

Parts list

Resistors:	Capacitors:
R1; R2 = 10 k	C1 = 180 p styrofoam
R3 = 33 k; 1%	C2; C3 = 15 p
R4 = 20 R; 1%	C4 = 47 p styrofoam or ceramic
R5; R6 = 10 k; 1%	C5; C6 = 100 n
P1 = 250 k preset	IC1 = SSM2015

level, particularly the current-noise contribution, has increased a little. Nevertheless, the preamplifier has a signal-to-noise ratio of 95 dB, measured with short-circuited + and - inputs and an output level of 0 dBV. Resistor R3 enables the source impedance to be matched to the input of the differential amplifier: if $Z = 600 \Omega$, R3 has an optimum value of 33 kΩ. With a 600 Ω resistor across the input terminals, the signal-to-noise ratio is of the order of 86 dB. The tables and the curve in Fig. 1 give a number of values for the bias resistor and compensation capacitors C2 and C3.

The differential inputs of the SSM2015 are of the floating type, so that external resistors, R1 and R2, are required to give a suitable DC setting. In single-ended (unbalanced) applications, care must be taken to prevent off-sets arising from biasing differences between the inputs, owing to different impedances (ground for one input, and the source for the other). Resistors R1 and R2 cause common-mode noise and must not be given a higher value than

shown in the diagram.

Off-set compensation with the aid of preset P1 is required for the given value of R3, which results in the available amplification of 1,000. The value of R3 depends on the gain setting - see Table 2. Capacitor C4 compensates the on-chip input current regulator, and C1 suppresses HF signals.

Distortion of the preamplifier at 1 kHz and 0 dBV was measured at less than 0.006% and less than 0.01% at a test frequency of 10 kHz. The half-power bandwidth is 180 kHz at 3 V across 1 kΩ. Common-mode rejection at 50 Hz is greater than 100 dB.

PMI states that the output of the SSM2015 is not intended to drive long lines: capacitive loads greater than 150 pF should be decoupled by a 100 Ω resistor in series with the output (but note that R5 must remain connected to pin 3).

(Precision Monolithics Inc.)

055

GENERAL INTEREST

HIGH-VOLUME ALARM

When this alarm is actuated by a low-level signal at input \overline{EN} , the (HF) loudspeaker produces a number of 4-tone sequences separated by quiet intervals. Each sequence sounds louder than the previous one to give the alarm a very distinctive character. The peak output is reached after about 28 seconds.

As long as the \overline{EN} input is logic high, counters IC1a and IC1b

remain reset and interval oscillator N2 and tone generator N3 are disabled. The alarm is then off.

When \overline{EN} is actuated, the oscillator and the two counters are enabled. Counter IC1a is clocked with pulses ($PRF = 8 \text{ Hz}$) from N2. Gates N1 and N4 at counter outputs Q0 and Q3 cause T1 to be turned off during eight consecutive clock cycles from IC1a.

During the next eight cycles, the transistor is alternately switched on and off as illustrated in the timing diagram. The loudspeaker sounds only when T1 conducts.

Since output Q3 of counter IC1a is connected to the CLK input of counter IC1b, the latter is incremented by the 16th negative pulse transition. In practice, this means that counter IC1b is clocked after each tone sequence. The most significant outputs of counter IC1b drive the 3-bit selection inputs of analogue multiplexer IC3. Since Q0 is not used, IC1b requires two clock pulses to enable the multiplexer to connect the next input, Xn, to the output, X. The seven resistors at the multiplexer inputs cause the base voltage of T3 to increase after each alternate tone sequence. As a result, the voltage across the loudspeaker increases, so that the alarm sounds louder.

Transistor T1 switches the successive beeps on and off. Resistor R16, capacitor C5 and transistor T2 prevent abrupt switching of the voltage across the loudspeaker when T1 is turned off, and ensure that the sound level reverts slowly to the level set by the resistor at the relevant multiplexer input.

After the alarm is actuated, the output volume rises sevenfold. Diodes D1, D2 and D3 cause counter IC1b to stop at state 1110, so that the multiplexer passes the full positive supply voltage at input X7 to volume control T3. The alarm then sounds continuously at maximum volume, requiring the power supply to provide a peak current of up to 1.25 A through the loudspeaker. The resultant sound is ear-piercing.

Preresets P1 and P2 serve to set the interval repetition rate and the sound frequency respectively.

(C. Sanjay)

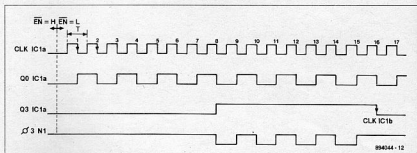
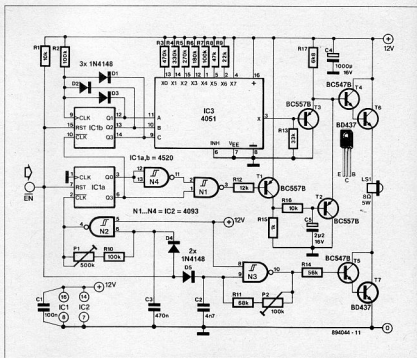

056

GENERAL INTEREST

MAINS POWERED TIMER

This timer may be inserted in a power line to provide a controllable delay before a load is energized. It was developed to work in conjunction with a passive infrared movement detector as part of an intruder alarm.

The mains voltage is reduced by C3 and rectified to give about 30 V across C1. This potential charges C2 slowly via R4-P1. When U_{c2} reaches about 14 V, electronic switch T1-T2 actuates a solid-state relay (a Type S202DS from Sharp). When the mains voltage is removed, C2 discharges rapidly via D6 and R10. The delay extends from 15 s (P1 set to minimum resistance) to 5 min (P1 set to maximum resistance).

The solid-state relay needs cooling in accordance with the current drawn by the load: at up to 1 A no heat sink is re-

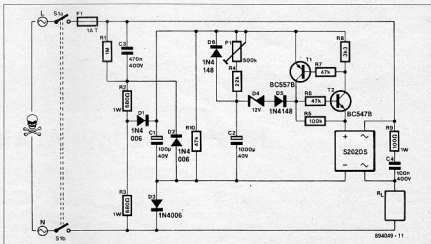

quired; at 1-3 A (max), a 5x5 cm heat sink is advisable.

During the building of the circuit, due consideration must be given to safety since many parts will be at mains potential. For instance, fitting the unit in an ABS or other man-made fibre enclosure is a must. If a potentiometer is used for P1, its spindle should be an insulated type. If a preset is used, it must not be accessible

through a hole in the enclosure.

Switch S1 is a DPST type that disconnects the circuit from the mains. Nevertheless, the only way of working on the circuit in safety is by taking the plug out of the mains socket and allowing C3 sufficient time to discharge.

(D. Dwyer)

057

GENERAL INTEREST

SINGLE-CHIP MELODY GENERATOR

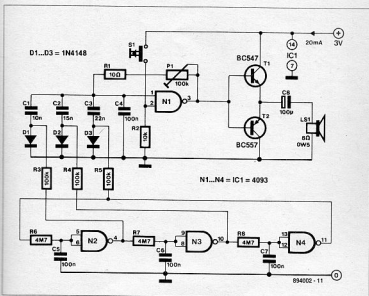

This melody generator, based on a Type 4093 CMOS Schmitt trigger, may be used in alarms, doorbells and cars (audible reverse gear or lights on indicator).

Three of the four NAND gates in the 4093 are connected in series by RC networks. Oscillation is effected by feedback of the output signal of N4 to the input of N2. The logic high levels produced by the cascaded gates in the oscillator circuit are used for biasing one of associated diodes D1, D2 and D3. The relevant diode connects one of frequency-determining capacitors C1-C3 to tone oscillator N1. The audio signal available when S1 is pressed is applied to complementary transistor pair T1-T2 that drives the loud-speaker.

The frequency of the emitted tone may be adjusted to individual taste by preset P1.

058

GENERAL INTEREST

INFRA-RED MICROPHONE

The circuit of this microphone was originally designed to monitor a 7-segment display used on the flight deck of a Boeing 737. That display used filaments, so that an IR detector was an obvious choice. In the Boeing, it was connected to a small portable

recorder: the sensor therefore acted as a microphone that reacted to IR light instead of to sound. This idea of an IR microphone is made more tangible by housing the device in the shell of DIN plug as shown in the photograph.

The IR microphone consists of a Type BP104 photodiode connected to the inputs of a DC-coupled operational amplifier, whose gain is determined by R1.

The device may be used to 'listen' to the visual world around us. It is particularly effective where sources of noise, such as incandescent light bulbs, are switched off. A gas flame, such as that of a cigarette lighter, is manifested as a soft breeze. A cosy fire burning in the grate comes out as a real hurricane. This means that the microphone may be used as an acoustic fire alarm, but that is about the only application we can think of. However, the circuit is intended more to give us an opportunity to see our environment from a different angle. If the BP104 is replaced by a BPW34, the sensitivity of the device is shifted from the infra-red to the visible spectrum.

The current drawn by the circuit depends to some extent on the supply voltage and should be 2-5 mA.

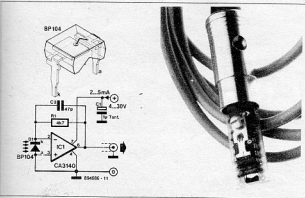

FOUR-QUADRANT DIMMER

This very special mains-operated dimmer for domestic or industrial lights is not available in proprietary form: it enables brightness control of two groups of lights in one operation. The possible combinations of brightness are shown in the table. It will be clear that it is not possible to obtain continuous control of brightness in the two groups. Instead, the circuit affords the setting of four states of brightness in either group: full on, fully dim-med, 1/3 on and 2/3 on.

Both sections of the circuit operate on the well-known principle of a triac being switched from the blocking state to the conducting state with the aid of an RC network and a diode. The RC network provides the necessary phase shift and determines when the triac is switched. The rotary switch selects the resistor in a given network and thus the brightness of the relevant group of lights. No resistor means that the group is off; a short-circuit gives maximum brightness, and resistors of 10 k Ω and 18 k Ω mean intermediate brightness. The diodes prevent the groups affecting one another.

The 64 μ H choke, L1, and the 150 nF capacitor across the bridge rectifier prevent the dimmer causing interference in other equipment connected to the mains.

If the triacs are fitted on a heat sink rated at 12 K/W, up to 500 W per group may be controlled. It is, of course, essential that the enclosure in which the dimmer is fitted provides ample cooling: a fair number of slots or holes in it are, therefore, essential: these should not permit the circuit elements to be touched.

The switch should have a non-metallic spindle: this is not only safer than a metallic one, but it also enables the easy removal of the end-notch so that the switch may be rotated continuously instead of having to be returned to the first stop every time it is operated.

It is recommended that mains on-off switch S2 is fitted with a built-in 'on' indicator bulb: this shows at a glance whether the circuit is on even though S1 may be in the off position.

Finally, do bear in mind that this circuit carries mains voltage in many places: good workmanship and insulation are, therefore, of the utmost importance.

(C.G. Mangold)

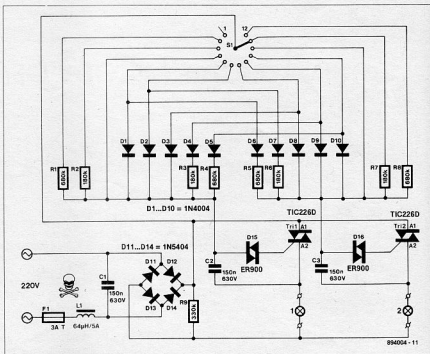

Switch position	Brightness	
	Group A	Group B
1	0	0
2	1/3	0
3	2/3	0
4	1	0
5	1	1/3
6	1	2/3
7	1	1
8	2/3	1
9	1/3	1
10	0	1
11	0	2/3
12	0	1/3

SENSOR SWITCH AND CLOCK

One Type TL084 IC and an old quartz watch enable the construction of a de luxe on-off switch. Two of the four opamps contained in the TL084 (A1 and A2) are used to amplify the input signals from the sensors hundredfold (with the component values as shown in the diagram). Just touching the sensors with a finger causes a good 50 Hz input signal (hum). Note that the amplifica-

tion drops rapidly with rising frequency.

Diodes D5 and D6 rectify (single-phase) the 50 Hz signal. Since the diodes are connected in anti-phase, touching the 'off' sensor results in a positive potential across C10, whereas touching the 'on' sensor gives a negative potential across C10.

Opamp A4 is connected as an inverting bistable, so that a nega-

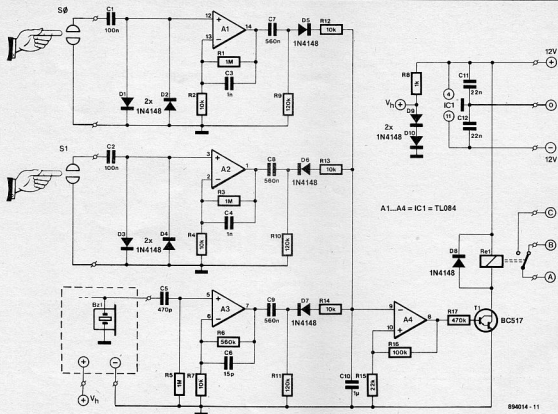

tive potential across C10 causes relay Rel1 to be energized. Because of feedback resistor R16, this state is maintained until the other sensor is touched.

The relay may also be energized at a predetermined time with the aid of a quartz watch. The 1.2 V supply for the watch is derived from the voltage drop across diodes D9 and D10: it may be increased to 1.8 V by adding a third diode.

The piezo buzzer in the watch is connected to the input of A3 via C5. As soon as the alarm goes off (the hour signal must be off), the voltage across C10 becomes negative, the relay is energized and the load is switched on.

The circuit, excluding the relay, draws a current of about 20 mA.

(R. Ochs)

061

GENERAL INTEREST

MINI-DRILL CONTROL

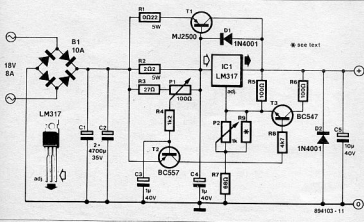

The circuit described here is intended as a revolution control for small DC motors as fitted, for instance, in small electric drills (such as used in precision engineering and for drilling printed-circuit boards, among others). The behaviour of these motors, which are normally permanent magnet types, is comparable to that of independently powered motors. In theory, the RPM of these motors depends solely on the applied voltage. The motor adjusts its RPM until the counter EMF generated in its coils is equal to the applied voltage. There is, unfortunately, a drop across the internal resistance of the motor and this causes the RPM to drop in relation to the load. In other words, the larger the load, the larger the drop across the internal resistance and the lower the RPM.

The present circuit provides a kind of com-

pensation for the internal resistance of the motor: when the current drawn by the motor rises, the supply voltage is increased automatically to counter the fall in RPM.

The circuit is based on an enhanced voltage regulator consisting of IC1 and T1, which provides a reasonably large output current (even small drills draw 2-5 A). The 'onset' supply voltage, and thus the RPM, is set by P2. Because of emitter resistor R1, the currents through IC1 and T1 will be related to one another in the ratio determined by R1 and R2. Owing to this arrangement, the internal short-circuit protection of IC1 will also, indirectly, provide some protection to T1.

As soon as the current drawn exceeds a certain value, T2 will

be switched on. This results in a base current for T3 so that R5 is in parallel (well, more or less) with R6. This arrangement automatically raises the output voltage to counter a threatened drop in RPM. The moment at which this action occurs is set by P1, so that the present circuit can be adapted pretty precisely to the motor used.

If only very small motors are likely to be used, the power supply (transformer and bridge rectifier) may be rated rather more conservatively. As a guide, the current in the transformer secondary should be about one and a half times the maximum DC output current.

(G.J. Lammertink)

062

RADIO & TV

CALL TONE GENERATOR

Amateur VHF relay stations are normally actuated by a 1750 Hz call tone. This may give problems when the relevant sending equipment has no internal call tone generator, or it has one whose frequency is not sufficiently accurate, or whose tone duration is not long enough to securely energize the relevant relay.

These problems can be overcome by the stand-alone generator described here. Simply placed in front of the microphone, it makes absolutely certain that the relay station is actuated.

The generator consists of a quartz oscillator, a frequency counter and a buffer-amplifier, all contained in just two CMOS ICs. It is powered by a 9 V PP3 battery, from which it draws a current

of around 5 mA.

Gates N1 and N2 form an oscillator that is controlled by a 3.27680 MHz crystal and provides clock pulses to IC2 which is connected as a programmable scaler. Diodes D1-D5 determine the divide factor of 1872. Counter output Q1 thus provides the wanted 1750 Hz signal, which is buffered by N3-N6 before being applied to a piezo electric buzzer. Capacitor C3 suppresses any harmonics, while R4 determines the volume of the output signal.

(N. Körber)

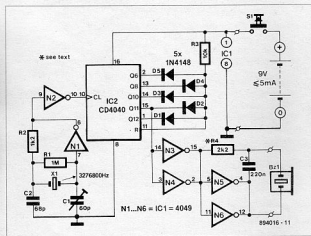

Parts list

Resistors:

R1 = 1 M
R2 = 1k2
R3 = 10 k
R4 = 2k2

Capacitors:

C1 = 60 pF trimmer
C2 = 68 p
C3 = 220 n

Semiconductors:

D1-D5 = 1N4148
IC1 = 4049
IC2 = 4040

Miscellaneous:

X1 = 3.2768 MHz; 30 p

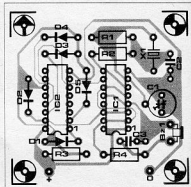

parallel
Bz1 = piezo electric buzzer

063

GENERAL INTEREST

MAINS FAILURE INDICATOR

When the mains voltage is present at the input terminals, the transistor in the optocoupler is on, T1 is off and silicon-controlled rectifier Th1 is in the conducting state. Since both terminals of the piezo electric buzzer are then at the same potential, the buzzer is inactive. If the mains voltage drops out, transistor T1 conducts and causes one of the terminals of the buzzer to be connected to earth; the thyristor remains in the conducting state. In this situa-

tion there is a large enough potential difference across both the buzzer and D5 to cause these elements indicating the mains failure both audibly and visibly.

When the mains is restored, the circuit returns to its original state. A touch on the reset button then interrupts the current through the SCR so that the thyristor goes into the blocking state, and the other terminal of the buzzer is connected to ground.

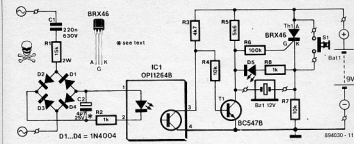

The unit is powered by a 9 V PP3 battery and draws a quiescent current of 1.7-2.5 mA.

It is important that the enclosure is a well-insulated type.

Finally two points to note. If by accident the circuit to the optocoupler and R2 is broken, electrolytic capacitor C2 may be damaged since it will be charged well above its 25 V rating. Secondly, where a plug is used for the mains connection, it is advisable to solder a 1M Ω resistor across C1 so that this capacitor does not retain its charge after the plug is removed from the mains socket.

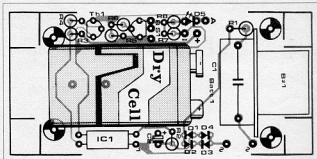

Parts list

Resistors:

R1 = 15 k; 2 W

R2; R8 = 1 k

R3 = 4k7

R4; R7 = 10 k

R5 = 5k6

R6 = 100 k

Semiconductors:

D1-D4 = 1N4004

D5 = LED

T1 = BC547B

Th1 = BRX46

IC1 = OPI 1264B

Miscellaneous:

S1 = switch with 1 make

contact

Bz1 = piezo buzzer 9 V

9-V PP3 battery

Capacitors:

C1 = 220 n; 630 V

C2 = 4 μ 7; 25 V

064

ELECTROPHONICS

GUITAR COMPRESSOR

The control of this compressor is based on the dependence of the dynamic resistance of a diode on the current flowing through it. The heart of the present circuit is the diode bridge D1-D4, which behaves as a variable resistance controlled by the current

flowing in T1.

The input signal is applied to preamplifier stage A1 via low-pass filter R1-C1 that removes any HF noise from the input. Switch S1 in the feedback loop of A1 sets the amplification to 1 (position

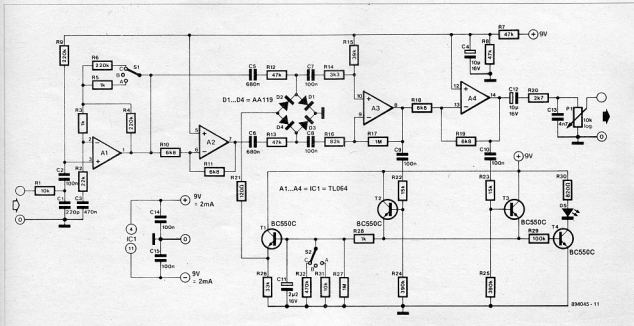

A), 6 (C) or 11 (B). The amplified signal is applied to the diode bridge direct via R12 and C5, and inverted via inverter A2, capacitor C6 and resistor R13. The two signals are summed by the bridge, amplified (in A3) and then split again into two, one of which is inverted by A4. The positive half cycles of the two signals are used to switch on T2 and T3 respectively. Capacitor C11 is then charged via R12. When the potential across this capacitor reaches a certain level, T1 is also switched on, after which a control current flows through the bridge via R21. This current lowers the resistance of the bridge so that the signal is attenuated (compressed). At the same time, the LED lights to indicate that the sig-

nal is being compressed. Capacitor C12 prevents any DC voltage from reaching the output.

The output signal is taken from the wiper of P1. Low-pass section R20-C13 limits its bandwidth to 12 kHz.

Switch S2 enables the selection of various decay times of C11. The values shown in the diagram have in practice proved to be the most useful. Nevertheless, these values are subjective and may be altered to personal taste and requirements.

(W. Teder)

065

TEST & MEASUREMENT

LC SINE WAVE GENERATOR

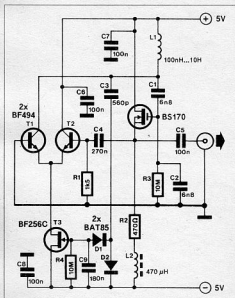

This compact LC oscillator offers a frequency range of about 1 kHz to almost 9 MHz and a low-distortion sine wave output.

The heart of the circuit is series-resonant circuit L1-C2-C3 in the feedback loop of amplifiers T1-T2. Transistor T2, which is connected as an emitter follower, serves as impedance converter, whereas T1, connected in a common base circuit, is a voltage amplifier whose amplification is determined by the impedance of L1 in its collector circuit and the emitter current. The feedback loop runs from the collector of T1 via the junction of capacitive divider C1-C2, source follower BS170 and the input impedance formed by R1 and C4. The whole is strongly reminiscent of a Colpitts circuit. The signal is also taken to the output terminal via C5.

Of particular interest is the amplitude control by the current source. The signal is rectified by two Schottky diodes, smoothed by C9 and then used to control the current through T3. The gain of amplifier T1 is therefore higher at low input levels than at higher ones. This arrangement ensures very low distortion, since the amplifier can not be overdriven.

The resonant frequency may be calculated from $f = 1 / 2\pi \sqrt{L1 C1 C2 / (C1 + C2)}$

With values as shown, it extends from 863 Hz ($L1 = 10$ nH) to 8.630 MHz ($L1 = 100$ nH).

The unit may be used to measure the Q of inductors. To that end, a potentiometer is connected in parallel with L1 and adjusted so that the current through the amplifier is doubled. The Q is then calculated from $Q = R_p / 2\pi fL$

066

TEST & MEASUREMENT

SHUNT FOR MULTIMETER

The current range in multimeters, particularly the more inexpensive ones, is restricted by the load limits of the internal shunts to 1-2 A. The photo shows how easily a precision heavy-duty resistor from Dale or RCL (0.1 Ω ; 20 W; 1%) may be used as an external shunt. These resistors were not designed for this purpose, but they are much cheaper than custom made shunt resistors. The 20 W rating applies only, by the way, if a heat sink is used: without that its rating is only 8 W.

The maximum current through the device on a heat sink is about 14 A; the larger versions draw up to 17.5 A. When mounting the shunt, make sure that the test terminals as well as the device terminals are soldered properly, otherwise the resistance of the

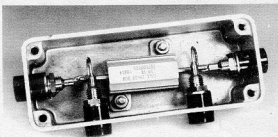
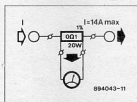

terminals is added to the shunt.

REAR WINDOW WIPER COUPLER

From any point of view, it is convenient to couple the rear window wiper on our cars to the windscreen wiper. Since the rear window of a moving car does not get nearly as wet as the windscreen, it suffices if the rear wiper operates only once for every 8, 16 or 32 wipes of the windscreen.

At terminal 53e (green/black wire), which is the return of the windscreen wiper motor, the clock signal for that motor is present. This signal, which is a square wave, is applied to the clock input of counter IC1 via R2-R3. The Q3 output of the counter goes high every eighth clock pulse, and the Q4 output once every sixteenth clock pulse. The output pulse is applied to monostable IC2 via switch S1. The monostable may be a Type 4528 (as drawn) or a Type 4548. At each trailing edge at pin 5, the monostable output (pin 6) goes high at a frequency of 1.5-16 Hz. When that happens, T3 is switched on, the relay is energized and the rear wiper operates.

The supply for the circuit is taken from terminal 53e also: during the intervals between the clock pulses, this terminal is at a potential of 12 V. In that state, T1 is switched on and C1 charges. When the clock signal is present at the terminal, T1 is off so that

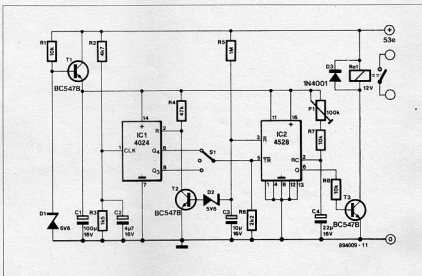

C1 can not discharge. Diode D1 limits the supply to 5 V.

A regular reset during the windscreen wiper interval is ensured by R4-R5-C3-T2-D2.

(G. Kleine)

PULSE SKIPPER

Noise and other interfering pulses on RS232 lines are the bane of a data processor's life. It is difficult to get rid of these pulses, because how does any relevant circuit differentiate between the real and the spurious? That is where the present circuit comes in: it skips those pulses at the input that are not constant for a given period or are shorter than normal.

The wanted pulses are delayed by about 55 ns plus the duration of the pulse. If parallel data lines are to be 'sterilized', it is imperative that the various pulse durations (delays) are equalized.

In Fig. 1, the input pulses are passed to an edge detector via buffer amplifier N1. The signal is passed both direct and delayed to, pulse shaper N10 via XOR gates N7, N8 and N9. For every pulse change at the output of N1, XOR gate N10 outputs a logic 0

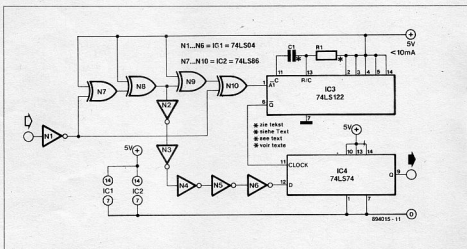

Fig. 1. Circuit diagram of the pulse skipper.

for about 30 ns. Moreover, each pulse variation at the input triggers monostable IC3. After a time $\tau = R1C1$, the monostable toggles

and returns to its original state.

At the same time, the toggling of the monostable generates an enable pulse for latch IC4. Each low-level pulse at the clock input of IC4 results in the storage of the momentary level at input D. The end of the clock pulse clears output Q, which afterwards only carries the stored level.

It is, of course, possible that during this process the input level has changed, which could lead to storage of the spurious pulse. To prevent this, the wanted signal is delayed by gates N2-N8 by about 65 ns before it is applied to input D of IC4 and stored. At the same time, it is ascertained that the level change at the input triggers the monostable before it is passed to the latch.

The action of the circuit is shown in the pulse diagram of Fig. 2. A normal pulse, that is, one that lasts longer than the time constant of the monostable, is present, after a short delay, at the Q4 output of latch IC4 in its original state (Fig. 2a). A spurious pulse, which is shorter than the time constant of the monostable, is absorbed in the circuit and does not lead to a level change at the Q4 output of the latch (Fig. 2b).

The circuit consists of four ICs, one resistor and one capacitor. It is easily fitted in a small enclosure or, better still, in the equipment that needs "sterilizing". In that case, the necessary supply voltage (5 V) will also be readily available.

If different time constants are needed, R1 may be replaced by a

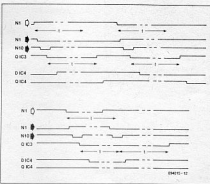

Fig. 2. Normal pulses are longer than the mono-stable time (a), while spurious ones are shorter (b)

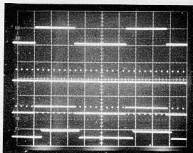

Fig. 3. Signals recorded from an oscilloscope. From the top: (1) data signal; (2) noise pulses; (3) distorted signal; (4) "sterilized" signal at the output.

1k5 potentiometer or by a number of fixed resistors brought into circuit by a rotary switch.

The time of the monostable is computed from

$$\tau = 0.7 R1 C1$$

Practical values for R1 range from 1k4 to 40 k Ω , while C1 may have values from 10 pF up to 1000 μ F.

(N. Körber)

069

GENERAL INTEREST

FLASHING-LIGHT CONTROL

Life without flashing lights has become unthinkable. The circuit described here is intended primarily for model constructors, but may also be used in warning or alarm systems in the 'real' world.

The circuit is conspicuous by its simplicity; yet, it can deliver a current of up to 3 A. It is thus possible for it to power two 21-W car bulbs and these emit quite a lot of light!

Model constructors may connect several bulbs in parallel: La1 lights when La2 does not and vice versa. It is also possible to use only La1 and omit La2.

The L165 from STM (formerly SGS) is a common or garden operational amplifier with a powerful output stage. If it is intended that the output current goes up to the full 3 A, the device must be mounted on a heat sink of 2.5 K/W. Note that the enclosure of the

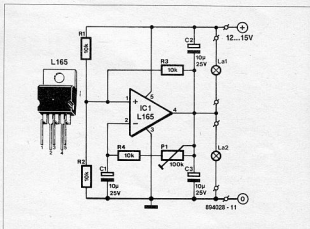

Parts list

Resistors:

R1-R4 = 10 k
P1 = 100 k preset

Capacitors:

C1-C3 = 10 μ F, 25 V

Semiconductors:

IC1 = L165 (L465)

Miscellaneous:

La1; La2 = 12 V, 21 W (max)
Heat sink 2.5 K/W (see text)

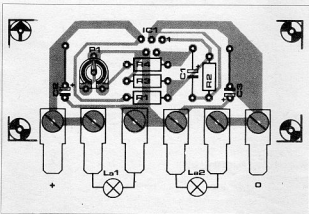

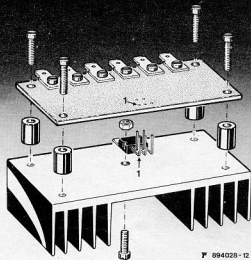

opamp is connected to pin 3. If the output current is not likely to exceed 0.5 A, a heat sink is not needed.

The L165 is internally protected against short-circuits and high temperatures.

If the brightness of the two bulbs is not the same, this may be corrected by adding a Type 1N5401 diode in one of the supply rails of the opamp. The relevant rail (pin 3 or pin 5) must then be decoupled by a 100 μ F, 16 V, electrolytic capacitor to earth.

The L165 may be replaced by a Type L465.

Excluding the bulbs, the circuit draws a current of about 15 mA. The power supply must therefore be rated at the maximum current through the bulbs.

070

COMPUTERS

DAYLIGHT-RESISTANT OPTOCOUPLER

Many X-Y plotters, particularly the DIY types, have, for all sorts of reason, no protection against incident light, so that the phototransistor in the optocoupler can not differentiate between the light from the associated LED and daylight. The circuit proposed here offers a solution to this problem.

A Type 555 timer pulses the LED in the optocoupler at a rate of 10 kHz. If, at the receiver end, only the signal at that frequency is amplified, neither daylight nor bright artificial light can disturb

the operation of the light barrier.

At a pulse rate of 10 kHz, the pulse spacing (or pulse repetition period) is 100 μ s. If the duty factor is 6:4, the pulse width is 60 μ s. At that rate, the LED can be pulsed at a fairly high current: about 45 mA. The pulsating current is fully compensated in relation to the voltage by C3.

The on-time of the pulse signal at the Q output of IC1 is determined by R1-R2-C1 and the off-time by R2-C1:

$$\text{pulse width } t_1 = 0.693C1(R1+R2) = 60 \mu\text{s};$$

$$\text{pulse spacing } t_2 = 0.693C1R2 = 40 \mu\text{s}.$$

The receiver in the optocoupler, that is, the phototransistor, is actuated by the reflected light from the light barrier and applies the consequent 10 kHz signal to a classical amplifier ($\times 80$) via C5. This capacitor and the input resistance of the amplifier form a high-pass filter. The collector of T1 has a d.c. potential of 3 V. Capacitor C8 and diode D1 cause a d.c. shift, so that at the anode of D2 positive pulses with a width of 60 μ s are present. These pulses charge capacitor C9 via D2 and R9. If sufficient pulsating light is reflected, that is, for instance, when the paper is less than 15 mm from the light barrier, the potential across C9 is sufficient to switch on T2. The output signal is then taken direct from the collector or via the relay (do not forget D3!).

The circuit draws a quiescent current of about 30 mA and an operational one of around 80 mA - in both cases, the relay current is not included.

(A. Schaffert)

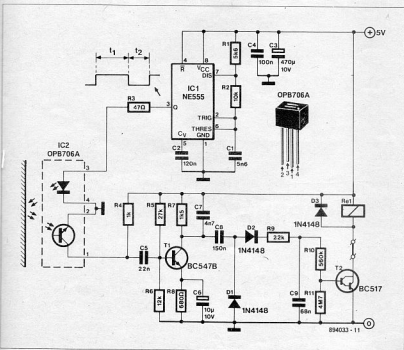

IMPROVED ECONOMICAL PORCH LIGHT

The practical application of the original circuit (Ref. 1) required a number of enhancements, resulting in the modified versions presented here.

The aim of the original design was to provide timed operation of a dusk-switched porch light. Presets P1 and P2 control the timing period and dusk threshold respectively. The circuit provides zero-voltage switching of the triac. The original design has been modified to make it suitable for installation in an enclosed porch immediately above a wall-mounted light.

Transistor T3 has been added as a shunt across C4 to allow the photocell to be disabled when the light is on. The sensor can thus be mounted close to, or even as part of, the light fitting without any problems.

The sensor continues to be disabled by D6 after the light is switched off. This prevents spurious retriggering by late-night visitors, when light from the hall may fall into the porch.

Diode D4 causes the light to be switched off when Q12 goes high, but the counter continues until Q13 goes high also: D2 then inhibits further counting. Diode D5 keeps the light off during the time the circuit is on standby for its day-light reset.

Capacitor C5 and resistor R14 prevent the circuit from locking with Q12 and Q13 high. The prototype of the circuit is reliably controlling a 60-W light.

Component changes around the 4060 slow the clock to restore the light's timing to the original range. For reliable operation, C3 must be a low-leakage polycarbonate or polyester capacitor: multilayer MKM or MKT types are preferred.

Reference "Energy-saving porch light"
Elektor India Aug/Sept 1984 p. 8-67

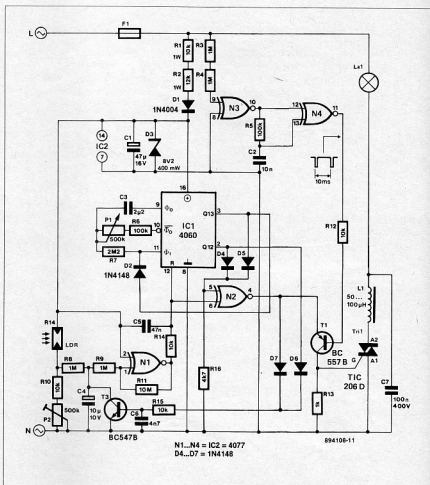

(S.C. Dellow)

RINGING PRUNER

If, like most of us, you get annoyed at times by the incessant ringing of the telephone, this circuit will keep your blood pressure down since it allows the telephone to ring only a few, predetermined, times.

Every time the telephone rings, the counter in the 4516 is increased by 1. The counter position at which the bell circuit is broken with the aid of a triac (Tri1) may be set at 1, 2, 4, 6, or 8. The bell signal on the A or B lines of the telephone is used as the

input for the circuit. It is split into two: a clock signal that raises the counter by one every time the bell rings, and a reset signal that puts the counter back to zero after the caller has hung up.

The bell signal is buffered by T1 and T2, each of which drives an RC network. When the bell rings, T1 is on and capacitor C2 is discharged via R6. At the onset of the interval between consecutive rings, the potential across C2 rises again and this causes IC1 to be clocked. The reset signal is produced in a similar manner,

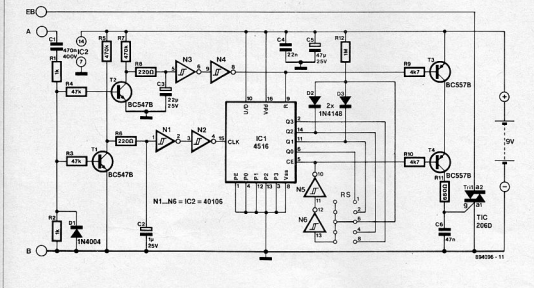

Fig. 1. Circuit diagram of the ringing pruner.

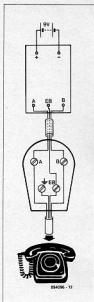

Fig. 2. See text.

but C3 takes much longer to recharge than C2. The recharge period is longer than the intervals between consecutive rings, so that the counter is reset only when the rings cease.

When the counter reaches the predetermined number, the CE (count enable) input goes high, so that further counting is not possible: T4 then switches off. This in turn switches off the triac, resulting in the bell circuit being broken.

Transistor T3 has been added to keep the current in the battery-powered circuit low: it removes the gate current from Tr1 as soon as the reset signal is high. In this state, the circuit draws a mere 10 μ A.

It is, of course, necessary to power the circuit from a battery in view of the connexion to the telephone network. A PP3 (9 V) battery is ideal.

In older types of telephone with a separate bell terminal, the

circuit is connected as shown in Fig. 2.

Note that the connexion EB-B in the telephone, plug or wall-mounted box must be removed to ensure that the triac is in series with the bell.

Electronic telephones with two-wire connexions may not allow the addition of the present circuit without some alterations inside them. With these telephones, it is better not to use a triac to prevent short-circuits. A miniature relay and freewheeling diode between the collector of T4 and earth are then used in place of R11, C6 and Tr1. A make contact of the relay is then connected in series with the bell.

It should be noted that in some countries the use of this type of circuit is not allowed. If in doubt, consult your local telephone or PTT manager.

073

POWER SUPPLIES

SMALL STEP-UP CONVERTER

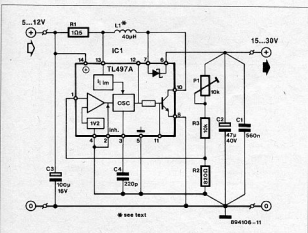

A draw-back of battery-based power supplies is their relatively low output voltage. The present circuit is intended to convert this 5-12 V output into a variable, higher one of 15-30 V.

The converter is based on an L497A from Texas Instruments, which is ideal for the construction of a fly-back circuit. Each switching period of a fly-back type of converter consists of two phases. In the first phase, the magnetic energy is stored in an inductor by connecting this to the input voltage via a conducting transistor. The current through the inductor rises linearly until a predetermined maximum (here set by R1 at 500 mA) is reached. In the second phase, the input voltage is disconnected from the inductor by the toggling of the transistor. The inductor then transfers its magnetic energy to an electrolytic capacitor by charging this via a diode.

The L497A contains an oscillator, a current limiting circuit to prevent the inductor from saturating, an error detector that compares the output voltage with an internal reference of 1.2 V, and a power transistor with freewheeling diode.

The oscillator has an on-time that is determined by C4. With

varying loads, the oscillator frequency shifts to adjust the duty factor.

The inductor may be a standard 40 μ H, 2 A, choke (the value is not critical), which is readily available. Electrolytic capacitor C2 is shunted by a good-quality decoupling capacitor, C1, to ensure removal of unwanted voltage peaks from the output. If the output is used to power an analogue circuit, it may be necessary to connect a small choke in series with it.

Capacitor C3 is necessary if the circuit is powered by a battery, since that invariably has a high internal resistance.

The layout of this type of circuit, in which relatively high peak currents may occur, is fairly critical. Start the construction with a star junction of C1, C2 and the output voltage divider.

From this junction, take an earth line straight to pins 4 and 5 of the IC. The emitter of the internal switching transistor must be connected direct to the negative terminal of C3. It is particularly important that the emitter current does not flow through the earth return used by the internal voltage reference (pin 4).

The peak output current depends, among others, on the difference between input and output voltages: it will normally be of the order of a few hundred milliamperes. The ripple on the output voltage is about 100 mV (this is always worse in switch-mode converters than in linear types). The stability, even with varying input voltages, is excellent, however.

The circuit draws a quiescent current of about 8 mA; its efficiency is around 70%.

074

GENERAL INTEREST

EEPOT

An EEPOT is an electronic potentiometer with built-in EEPROM that memorizes the last-set potentiometer position without needing a supply voltage. It is a linear device available in three standard values: 10 k (X9103); 50 k (X9503); and 100 k (X9104). To render its linear characteristic into a logarithmic one, a resistor with a value of one tenth the nominal value of the potentiometer must be connected between pins 5 and 6.

The EEPOT has three control terminals: an up/down input (U/D) where the direction of travel is determined; a clock input (INC) that enables the wiper to be moved one step at a time; and a chip enable (CE) input that enables the potentiometer to be selected. The CE line serves a second function in the programming of the EEPROM: the contents of the counter are not written into the memory until the leading edge of the CE signal arrives. A glance

at the circuit shows that \overline{CE} is always low. The EEPROM is thus not programmed, so that the potentiometer is always at zero at power-on.

If it is required that the last set potentiometer position be available at power-on, the input signals of N1, N2 and the output of N9 must be connected to the trigger inputs of a retriggerable monostable with a mono time of about 2 s. The Q output of the monostable then serves as the \overline{CE} signal. The monostable prevents the unnecessary programming of the EEPROM when the potentiometer is being adjusted; only after nothing has changed for two seconds is the position memorized.

Since the selection of the hundred positions of the potentiometer by switches alone would be a lengthy procedure, the circuit provides an automatic repeat facility. The cascaded network N3-

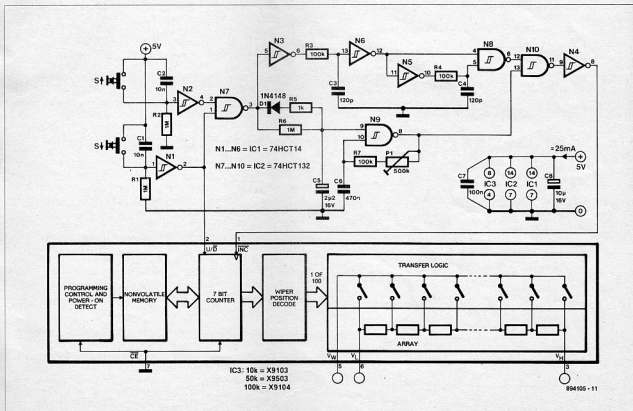

-N8 ensures that the circuit reacts instantly to a key being pressed. To that end, the switching pulse is delayed slightly by R3-C3 to enable the U/D input to stabilize. The delayed pulse is then compressed to 20 μ s by N5-R4-C4-N8 to enable repeat pulses also reaching the INC input.

In the network shunting N3-N5-N6-N8, capacitor C5 is

charged sufficiently after one second to cause pin 9 of N9 to go high, which results in this gate generating square waves, whose frequency may be set between 5 Hz and 30 Hz by P1.

The voltage at the potentiometer terminals should not exceed ± 8 V and should preferably be kept to ± 5 V. The current through the wiper terminal should not exceed 1 mA.

075

TEST & MEASUREMENT

LED VOLTMETER IN SMT

The voltmeter described has been designed primarily for monitoring the charging and discharging of a car battery. Because of its very small dimensions, it may be fitted anywhere on the dashboard.

The unit is based on quad opamp Type LM324, which is inexpensive and can work direct from the car battery. The voltage indication is obtained from a comparison of the battery voltage and a reference voltage at each of the four opamp inputs. The reference voltage is obtained from a zener diode that is operated via bias resistor R1, which allows a current of about 6 mA.

The zener voltage of 5V6 was chosen deliberately, since zener diodes operating between 5 V and 6 V have the best temperature stability. Moreover, even if the battery voltage is low, the drop across R1 is sufficient for correct operation.

The reference voltage is applied direct to the negative input of A1 and to the other opamps via potential divider R2-R4-P1. The potentiometer provides fine setting of the reference voltage (zener tolerance!).

The ratio R5:R6 has been chosen to ensure that the levels of the battery voltage stated alongside the LEDs are directly proportional to the reference voltage steps.

(M. Thurn)

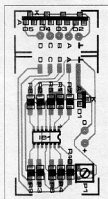
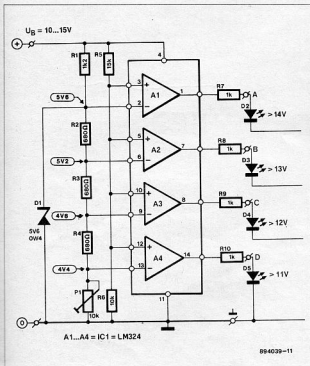

Parts list	
Resistors:	
R1 = 1k2	
R2-R4 = 680R	
R5 = 15 k	
R6 = 10 R7-R10 = 1 k	
P1 = 10 k preset	
Semiconductors:	
D1 = zener diode 5V6, 400 mW	
D2-D5 = LED	
IC1 = LM324D	

076

COMPUTERS

RS232 INTERFACE FOR C64

Although the Commodore C64 at the time of its introduction created a sensation, it has a number of drawbacks. One of these is the non-standardization of the connexions. Plugs, sockets and signals are not always compatible with a host of other equipment, such as printers, modems and other computers. The interface presented here transforms the serial output to a standard RS232 connexion.

The quasi-RS232 connexion is found at the rear of the C64. Some lines of the user I/O connector are used for the present purposes. Unfortunately, just a few lines to a standard 25-way D-type

connector as used for RS232 connexions are not enough. What is also needed is the conversion of the TTL signal levels to RS232 levels, that is, to between +5 V and +25 V for a logic zero, and to between -5 V and -25 V for a logic one. To this end, the 9 V a.c. available on the user I/O connector is converted to a symmetrical d.c. supply. The positive supply is obtained by simple, single-phase rectification by D1 and C1.

Obtaining the negative rail is slightly more complicated, since the a.c. line is internally connected to the logic earth. Therefore,

during each half cycle at pin 11 of the I/O connector, C2 is charged via D2. During the negative half cycles, C2 will trickle-charge C3 via D3. Note that the 'negative' is hardly negative with respect to logic earth, although it is relative to pin 10.

Although the symmetrical supply so obtained is not very stable, it is more than adequate for powering RS232 line driver IC1.

The four most frequently used RS232 signal lines, that is: TxD - transmitted data; RxD - received data; RTS - request to send; and CTS - clear to send, are provided at the standard RS232 connector via gates N1-N4.

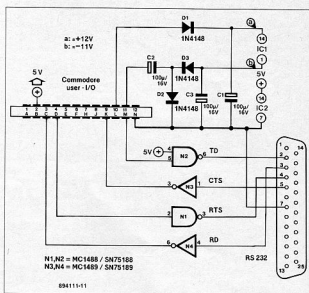

077

CAR ELECTRONICS

REAR WASH-WIPE CONTROL

Although many cars, where necessary, are now fitted with a rear wash-wipe facility, few provide intermittent operation of it. The control described here provides switch-on delay for the rear wash and a switch-off delay for the rear wipe operation. To that end, the existing connexion between the on-off switch and the motor, and that between the wash and wipe motors, must be broken. Normally, this can be done in the relevant compartment in the boot (or rear of an estate car).

The circuit is connected between these three wiring breaks. The positive motor terminals are connected to the relay contacts (rated at not less than 16 A), while the other terminals are connected to the +12 V line. Some extra cable may be needed here. The motor earth is normally connected direct to the car body. Some cars have a positive-earth system: that makes no difference as far as the relay contacts are concerned. The polarity does not matter to the remainder of the circuit either (but be careful not to cause a short-circuit), although S1 must be arranged to switch in the positive line only.

Most of the noise and other interference pulses are removed from the 12 V vehicle supply by D1-R1-C1: the resulting voltage is perfectly suitable for CMOS devices.

Standard relays (12 V, 16 A) with one make contact may be used: special car relays draw rather more current.

Input filter R2-C2 debounces push-button switch S1 and at the same time provides appropriate time constants for Schmitt trigger IC1. When S1 is closed, C3 charges rapidly via D2, but discharges only slowly via R4 when the switch is released. Only when the signal drops below a certain level does the Schmitt trigger when

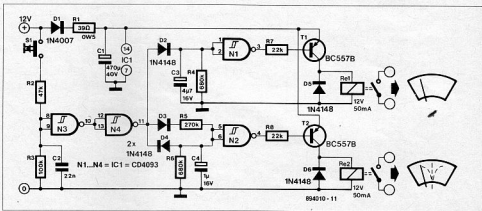

off relay Re1 via T1 (switch-off delay). With values as shown, the delay is about 2 seconds.

The delay for the wash motor is obtained in an identical, but reversed, manner. For this, electrolytic capacitor C4 is charged slowly via R5 until the required threshold level is reached, which takes about 0.5 s with values as shown in the diagram. It is then discharged rapidly via D4.

When S1 is pressed briefly, the rear wiper operates once or twice. When it is pressed for more than around 0.5 s, the wash motor causes a little water to be squirted onto the rear window while the wiper operates.

It is common experience that the rear wash-wipe facility is not needed nearly as often as that of the windscreen. Nevertheless, the delay times in the present circuit may be altered by changing the resistor values as appropriate. Combining the control with the windscreen intermittent switch is only feasible if relatively short clock pulses are available at that switch.

To prevent condensation on the circuit, it is not advisable to fit it in a closed box.

(A. Schaffert)

DIFFERENTIAL AMPLIFIER

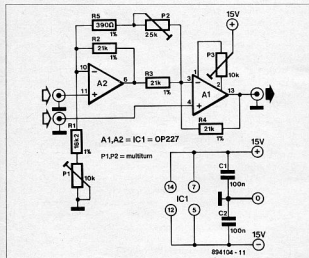

Differential amplifiers are normally designed with the aid of one or three operational amplifiers. A good-quality type (instrumentation amplifier) may also be constructed from two opamps as described here. The quality of the amplifier is largely dependent on the stability of the components used.

To ensure adequate suppression of common-mode signals, the following relation must be true:

$$R2R4 / (R1 + P1) R3 = 1.$$

Preset P1 makes it possible for this condition to be met, whatever the tolerance of the other components. The circuit may be simplified by choosing the same value for R2, R3, and R4. In that case, the amplification of the circuit is:

$$2[1 + R_x / (R5 + P2)]$$

in which $R_x = R1 + P1 = R2 = R3 = R4$.

A Type OP227 was chosen because of the very good and virtually identical specifications of the two opamps it contains.

The circuit draws a current of about 7 mA.

HF PROBE FOR OSCILLOSCOPE

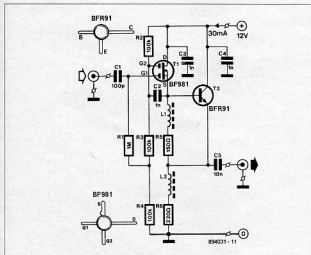

Fig. 1. Circuit diagram of the HF probe.

This active probe will allow the measurement of signals up to at least 100 MHz. It has the benefits of loading the metering point to only a negligible degree and not being loaded by the cable that connects it to the oscilloscope.

The circuit is basically nothing more than a voltage follower. The negligible loading of the metering point is achieved by the use of a dual-gate MOSFET. Since that device makes the input impedance of the circuit too high, the impedance is brought down to the standard value of 1 M Ω by R1.

The probe is constructed on the small printed-circuit board in Fig. 2. Regrettably, that board is not available ready made, but drawings of it on paper or film may be obtained at low cost - see the Readers' services section towards the end of this magazine.

Parts list

Resistors:

R1 = 1 M
R2-R4 = 100 k
R5 = 150R
R6 = 220R

Capacitors:

C1 = 100 p
C2-C4 = 1 n (ceramic)
C5 = 10 n (paramic)

Inductors:

L1, L2 = 4 turns on grey ferrite bead

Semiconductors:

T1 = BF581
T2 = BFR91

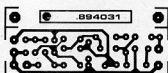
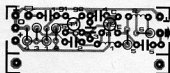

Fig. 2. Printed-circuit board for the HF probe (not available ready made)

POWER SUPPLY WITH EEPOT

The EEPOT control described elsewhere in this supplement (Circuit No. 074) is eminently suitable for use in a variable power supply. The advantage of this is that the EEPOT is then fitted where it should: in the circuit and not on the front panel or some other remote place. That arrangement reduces the likelihood of hum, noise and other interference on the power lines.

The power supply proper is fairly simple to build. A stable reference voltage of 6.9 V is provided by an LM329. This potential is used for setting the output voltage via preset potential divider P2-P4-R2, where P4 is the EEPOT.

The power section of the circuit is based on IC1 and T1 which together behave as an operational amplifier as far as positive voltages are concerned (negative ones do not occur here, of course). This combination (together with P1, R5 and R6, is configured as a non-inverting amplifier. This means that the potential across the output terminals is proportional to the voltage at the wiper of P4. Potentiometer P1 serves to set the maximum output voltage, and P2, the minimum output voltage. Moreover, at power-on the output voltage will be a minimum because no use is made of the integral memory of the EEPOT.

To protect the power supply, current limiting is provided. To

that end, the output current is converted to a voltage by R11. As soon as that voltage (presettable by P3) is high enough to switch on T2, the voltage regulation of the circuit is replaced by current regulation via the strobe input of IC1. Depending on the setting of the controls, the maximum current lies between 0.8 A and 3 A. To ensure that T1 is not damaged at maximum dissipation, the current must not exceed 1.5 A when the output terminals are short-circuited.

Alignment of the circuit is not difficult. First, set P4 at maximum resistance and wait a minute or so to let Z1 and IC1 reach their normal operating temperature. Next, adjust P1 to give an output voltage of 25 V. Finally, set P4 to minimum resistance and adjust P2 to give an output voltage of 250 mV.

The minimum output voltage is chosen deliberately at 250 mV, because that ensures that the various components operate on a linear section of their characteristics at all times. It also ensures that each of the 100 steps of the EEPOT is equivalent to 0.25 V.

A separate small power supply for the EEPOT is provided by R12, Z2 and C4. Two points need to be borne in mind here: the earth lines must be run as shown in the diagram, and T1 must be mounted on a heat sink of about 1.5 K/W.

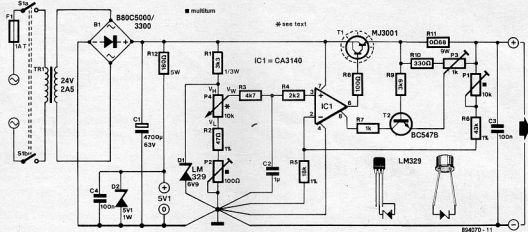

ONE OR TWO MBIT EPROM PROGRAMMER

More and more computers are fitted with a 1 Mbit or 2 Mbit EPROM. The programming of these devices is rather more complicated than that of the well-known 27128 types. Moreover, there are only a few programmers on the market that can process these large EPROMs, and those are fairly expensive. The holder described here enables the large EPROMs to be

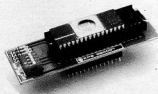

programmed by a standard 27128 programmer. The only proviso is that the large EPROM has an 8-bit wide data bus and a non-segmented address range, that is, continuous – not split into banks: in other words, a 8x128 Kbyte or 8x256 Kbyte type.

It is seen from the circuit diagram that part of the address decoding is effected with the

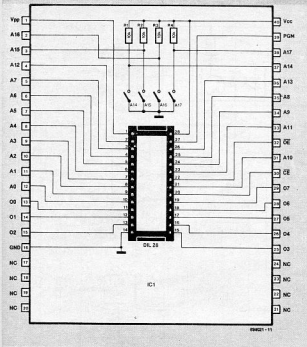

aid of four DIP switches. This is possible because externally the only difference between a 27128 and the larger types lies in address lines A14, A15, A16, and possibly A17. These DIP switches arrange the splitting of a 1 Mbit EPROM into eight 128 Kbyte blocks (note that A17 is absent from the 1 Mbit type), while a 2 Mbit type is split into sixteen 128 Kbyte blocks.

The proposed holder therefore enables the larger EPROMs to be

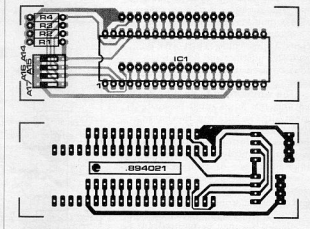

programmed in eight or sixteen blocks, which makes it much simpler.

At the onset, when all DIP switches are in position ON, insert the master (donor) EPROM into the ZIF (zero insertion force) socket and start the programmer's reading of the contents. Replace the donor EPROM by the 1 Mbit or 2 Mbit EPROM, as the case may be, and commence its programming. This procedure must be repeated eight (1 Mbit) or sixteen (2 Mbit) times, each with a different setting of the DIP switches.

Construction is fairly simple. Use a ZIF socket for the holder: this enables the insertion and removal of EPROMs many times without damage to the pins. Unfortunately, these sockets are available only with 40 pins. That is why the lower eight pins in the diagram are not connected.

The connections between the circuit and the programmer may be made, for instance, with the aid of a wire-wrap socket as shown in the photograph.

082

ELECTRONICS

MIDI INTERFACE FOR AMIGA

Although the Amiga is not available with a MIDI interface, it is fortunately not too difficult to convert its RS232 output to a MIDI output. The circuit to do that is inexpensive and fully compatible with ready-made interfaces, so that existing software can be readily used with it.

A MIDI interface is a serial interface that makes use of a current

loop. The speed on this serial channel is pretty high: 31,250 baud. The design of the Amiga allows operation of the computer at that speed, which makes the construction of the interface fairly simple. In fact, all that is required is a converter to translate the serial data on the RS232 interface (voltage) into a MIDI signal (current). As is evident from the circuit diagram, only few components are needed for this: three ICs, an optocoupler and some resistors and capacitors.

The MIDI input, K1, converts the input current into a voltage via optocoupler IC2. Part of the serial data is taken to MIDI throughput K2 via buffers N1 and N2. The remainder of the data is taken to the RS232 interface via RS232 driver IC1.

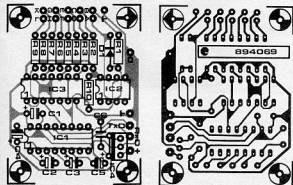

Parts list

Resistors:

R1-R9 = 220R
R10 = 1k

Capacitors:

C1 = 10 μ ; 16 V
C2-C5 = 1 μ ; 16 V (radial)
C6 = 100 n

Semiconductors:

D1 = 1N4148
IC1 = LT1081
IC2 = 6N136
IC3 = 74LS14
IC4 = 7805

Miscellaneous:

K1-K5 = 5-pin DIN

At the same time, serial data from the computer is taken to three MIDI outputs via driver gates.

Because of IC1, the circuit is protected against voltages that occur on an RS232 interface and it can, therefore, be used in combination with other computers.

The wiring from the PCB to the various DIN buses must be made manually. Populating the board itself should not present undue difficulties. Unfortunately, the PCB is not available ready made, but drawings on paper or film may be ordered at low cost - see the Readers' Services section towards the end of this magazine.

Where a regulated 5-V supply is available, IC4 may be omitted. In that case, a wire link must be placed between connexions 1 and 2 for IC4.

There is not much that needs to be said about the use of the interface. Connect it to the RS232 output, after which any of the special MIDI programs, like Aegis Sonix, Studio Magic, Musi Mouse, and many more, may be used for many hours of pleasure.

(E. Ponsen)

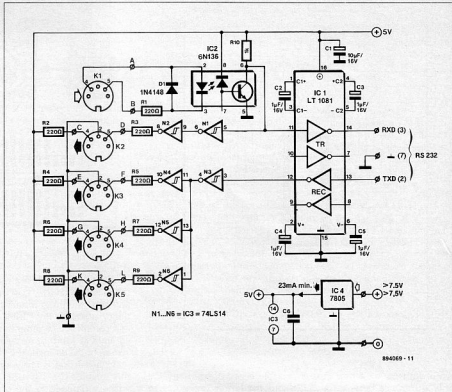

083

GENERAL INTEREST

AUTOMATIC CHARGER ADD-ON UNIT

Lead-acid-battery chargers are fairly inexpensive these days, but unfortunately most of them are also made on the cheap. For example, although it is important for charging to cease once the battery is fully charged, there are few, if any, chargers in the low to medium price bracket that offer this facility. The proposed add-on unit switches the charger off when the battery voltage rises above 13.8 V (this may be set somewhat higher when the unit is used with a booster charger) and switches it off again when the battery voltage drops below 12.6 V.

The circuit has its own power supply, a 12-V mains adaptor,

since otherwise flat batteries could not be charged.

Opamp A4 and zener diode D7 provide a stable reference voltage. When the charger terminals are open-circuited, the input current of the opamp produces a small drop across R4. This voltage causes the output of opamp A2 to go low. The relay is not energized and the charger may be short-circuited with impunity. Only when a potential of not less than some tens of millivolts exists across the charger terminals is the relay energized and does the charging of the battery begin. If the battery has been connected with incorrect polarity, nothing can happen because the relay does

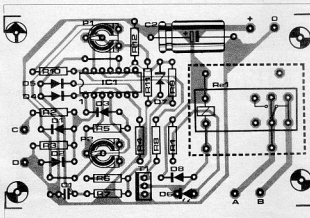

Parts list

Resistors:
 R1 = 470 R
 R2, R3 = 100 k; 1%
 R4 = 1 M
 R5 = 100 k
 R6 = 8k2
 R7 = 10 M
 R8 = 10 k
 R9 = 270 R
 R10 = 3k3
 R11 = 22 k
 R12 = 270 k

Capacitors:
 C1 = 1n5
 C2 = 100 µ; 16 V

Semiconductors:
 D1-D5 = 1N4148
 D6 = LED (green)
 D7 = 5V6; 400 mW zener
 D8 = 1N4001
 T1 = BD679
 IC1 = LM324

Miscellaneous:
 P1, P2 = 5 k preset
 Mains adaptor 12 V, 250 mA
 Re1 = relay, 12 V, 250 mA
 Enclosure (e.g. OKW2492)

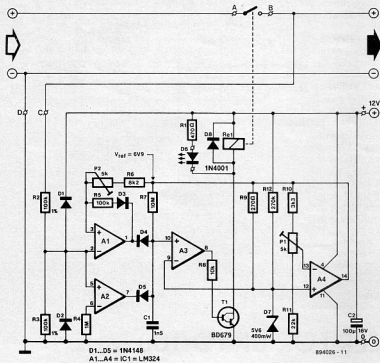

not become energized.

When a battery is connected to the charging terminals, the output of A2 goes high. As long as the battery voltage is lower than 13.8 V, the output of A1 remains high. The relay is then energized and charging begins. The relay should be of a type that can switch currents of at least 5 A: a vehicle type is ideal. As soon as the battery voltage gets too high, the output of A1 goes low and the relay is deactuated. Since the charging current into a fully charged battery is small, the switching of the relay creates no problems.

The add-on unit may be built on the PCB shown, which is, however, not available ready made. Drawings on paper or film may be obtained at low cost - see the Readers' Services section towards the end of this magazine.

Alignment of the circuit is fairly simple. The value of the reference voltage is set by P1 and is correct when the output of A4 is exactly 6.9 V. Since resistors R2 and R3 have the same value, the add-on unit switches off when the battery voltage is exactly 13.8 V. Resistor R5 and diode D3 provide some hysteresis whose magnitude may be set by P2.

After the reference voltage has been set, the battery may be charged until the relay is de-energized. Then, adjust P2 until the voltage at pin 3 of A1 is exactly 6.3 V. This ensures that charging begins when the battery voltage drops below 12.6 V.

(H. Huynen)

084

GENERAL INTEREST

SMOKE DETECTOR

One of the better ways of detecting smoke is the use of an ionization chamber. Unfortunately, these devices are not without danger because they contain a small amount of radioactive material. They should, therefore, NEVER be opened for whatever reason. If they are defect, do NOT put them in the dustbin, but take them to one of

the special council depots for dangerous waste materials. When you buy one of these chambers, make sure that is of an approved standard.

Apart from the small amount of radioactive material, the chamber contains two electrodes, one of which is normally formed by the enclosure - see photograph.

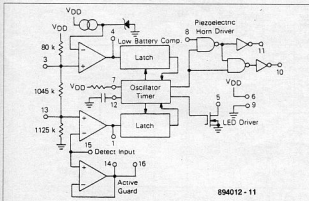
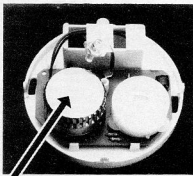

Fig. 1. Circuit diagram of the MC14467



When the air is not contaminated by smoke the resistance between the electrodes is high; when smoke particles enter the chamber, the resistance drops. The same particles cause a charge between the electrodes, so that a current begins to flow between the electrodes. This current is minute so that the electrical connection between the chamber

and the circuit is critical. Normally, the ionization chamber is quite separate from the printed-circuit board or the board is provided with a track around its perimeter that is at the same potential as the chamber. That arrangement prevents leakage currents to other tracks on the board. The potential may be measured at low-ohmic pins 14 or 16, but not at high-ohmic pin 15.

The necessary electronics is usually housed on one chip, for instance, Motorola's Type MC14467. The internal oscillator of this IC provides the timing, which may be altered by changing the values of R2 and C3. Resistor R1 is the normal bias resistor for D1 through which a current of about 10 mA flows at every 24th clock pulse. This current is also used for monitoring the state of charge of the battery. This is the reason that the current must not be lowered, because then the battery test becomes unreliable.

Testing the IC is rather tricky, because, in order to economize on current, it switches itself on for only 10 ms every 1.67 s: during that period it draws about 50 μ A plus the LED current. However, the IC may be made to work continuously by connecting pin 12 temporarily to the 0 V rail.

When the alarm sounds (smoke!), the voltage at pin 13 drops to about 0.1 V. The alarm may be tested by pressing switch S1.

(Source: Motorola)

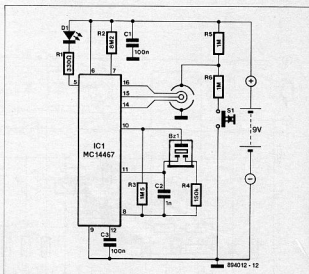

085

RADIO & TV

VFO STABILIZER FOR UP TO 100 MHz

The stabilizer presented here enables the precise tuning of h.f. oscillators if these have a control input. That input is normally used for varying the capacitance of a varactor.

The signal at the input is amplified by a fast operational amplifier, IC1. The output of this opamp is a rectangular signal that is applied to the D input of bistable FF1. The clock input of the bistable is provided by generator IC3. The two outputs of the bistable are the product of the clock and the input signal. The fre-

quency of this composite signal lies between 0 Hz and half the clock frequency. To ensure the best possible control characteristic, the output signal of the bistable is compared with a reference signal that has a frequency one quarter that of the clock. To that end, a second bistable, FF2, is connected as a binary scaler; its input is provided with a signal whose frequency is half that of the clock applied to FF1.

The differentiating network at the output of FF1 uses only the

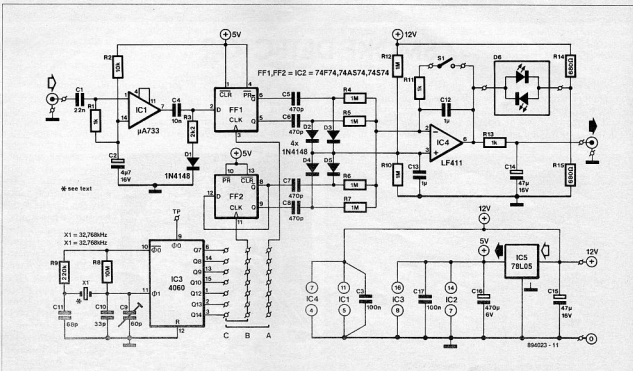

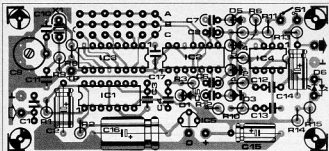

Parts list

Resistors:

R1, R11, R13 = 1 k
 R2 = 10 k
 R3 = 2k2
 R4-R7, R10, R12 = 1 M
 R8 = 10 M
 R9 = 220 k
 R14, R15 = 680 R

Capacitors:

C1 = 22 n (ceramic)
 C2 = 4μ7; 16 V
 C3 = 100 n (ceramic)
 C4 = 10 n (ceramic)
 C5-C8 = 470 p (polyester)
 C9 = 60 p trimmer

C11 = 68 p
 C12, C13 = 1 μ (MKT)
 C14, C15 = 47 μ; 16 V
 C17 = 100 n (MKT)

Semiconductors:

D1-D5 = 1N4148
 D6 = LED (two colours)
 IC1 = μA 733
 IC2 = 74F74 or 74S74 or 74AS74
 IC3 = 4060
 IC4 = LF411
 IC5 = 78L05

Miscellaneous:

S1 = single-pole switch

negative pulses of the output signal, whereas that at the output of FF2 uses only the positive pulses. All these pulses are combined in an integrator, resulting in a stable voltage. Since both the Q and the \bar{Q} output are used, the ripple is halved.

If the frequency of the input signal is not stable, the amplitude of the integrated signal varies. The variations are used to control the oscillator in a manner where the deviations are negated.

The clock is constructed around a 4060 and an inexpensive watch crystal. This crystal may, of course, be replaced by a different type, as long as this has the required stability.

The clock frequency, and thus the required grid, is set with the aid of jump leads. The frequency on row B must always be half that on row A.

The construction and alignment should not present any undue problems if the circuit is built on the ready-made PCB.

The oscillator is set to exactly its centre frequency by C9; this can be verified at test point T_p, which carries the buffered clock frequency.

The circuit is powered by a 12-V supply that is brought down to 5 V and stabilized by regulator IC5.

Indicator D6 remains out as long as the oscillator frequency is stable. If the frequency drifts, the LED lights; its colour and intensity indicate in what direction the drift occurs and how serious the drift is.

The integrating action may be disabled by S1, which enables the circuit to settle down more rapidly than with it on.

086

TEST & MEASUREMENT

CRYSTAL TESTER

In this easy-to-build tester, an LED indicates whether a crystal oscillates or not. The unit is best constructed on the printed-circuit board, which is, however, not available ready made. Drawings can be supplied on paper or film at low cost, however – see the Readers Services section towards the end of this magazine. As always in h.f. circuits, all wiring, terminals and pins should be kept as short as feasible.

Although the tester was designed primarily for use with fundamental-frequency crystals between 1 MHz and 30 MHz, the prototypes worked satisfactorily with overtone crystals also.

Many crystals in the range 1-4 MHz oscillate more readily

when switch S1 is closed.

The current drawn by the tester is typically not greater than 30 mA at 9 V.

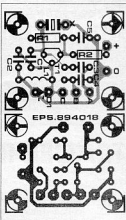
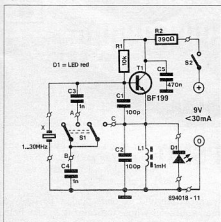

Parts list

Resistors:

R1 = 10 k
 R2 = 390 R

Capacitors:

C1, C2 = 100 p
 C3, C4 = 1 n
 C5 = 470 n

Semiconductors:

D1 = LED (red) 3 mm
 T1 = BF199

Miscellaneous:

L1 = 1 mH
 S1 = 2-pole switch
 Crystal socket

SMALL I/O CARD

Although the I/O card presented here is small, it offers no fewer than 24 I/O lines for a number of applications. If the computer has enough slots, up to eight of the cards may be installed.

The circuit is fairly simple: an address decoder and an I/O chip. The addresses are set out in the table. The circuit is fitted on a double-sided printed-circuit board that is just a little wider than connector K1. The amount of unused space on the board is filled with soldering pads for use by those who are keen on experimenting. Make sure when fitting the board that connector K1 faces outwards through the opening in the PC enclosure.

To keep costs down, the PCB, although double-sided, is not through-plated and it is, therefore, advisable to solder IC1-IC3 direct on to the board. A holder may be used for IC4, but even then the pins have to be soldered at both sides of the board.

Owing to lack of space, it is not possible to give the programming information for the Type 8255 I/O chip here, but that is, of course, given on the data sheets for the device. It is also contained in, among others, our Data Sheet Book 2.

(S. Mitra)

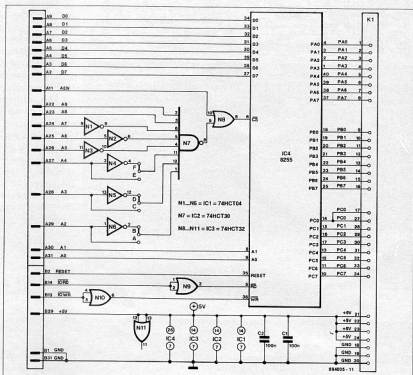

Address range (hexadecimal)	Jump leads
300-303	B, D, F
304-307	A, D, F
308-30B	B, C, F
30C-30F	A, C, F
310-313	B, D, E
314-317	A, D, E
318-31B	B, C, E
31C-31F	A, C, E

Parts list	
C1, C2 = 100 n	
IC1 = 74HCT04	
IC2 = 74HCT30	
IC3 = 74HCT32	
IC4 = 8255	
K1 = 34-pin right-angled male header	
PCB 894005	

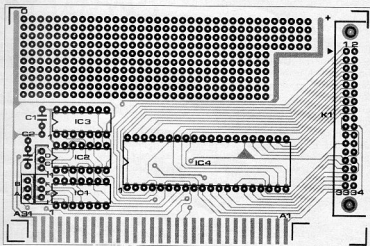

VOLTAGE TRACER IN SMT

A voltage tracer is a handy tool at any time and when it is made in surface-mount technology – SMT – it becomes even more useful,

since it is then easily carried around in one's pocket. Basically, a voltage tracer is a small voltmeter whose indicator is an LED. Both

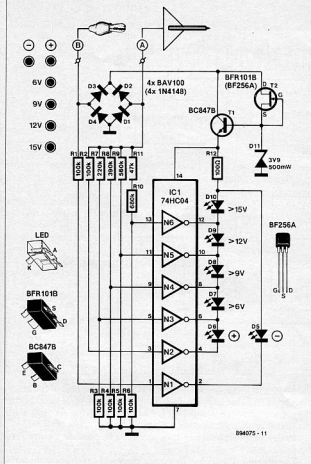

the value and the polarity of the voltage under test are indicated. If the main prong, that is, the one connected to the sharp end of the PCB, is negative with respect to the auxiliary prong, only the -LED lights. If, however, a positive voltage is measured, one of the five +LEDs lights. Which one depends on the magnitude of the voltage. If an alternating voltage is measured, the -LED and +LEDs will light simultaneously.

The actual measurement is carried out by an HCMOS IC. As soon as the input voltage of one of the gates exceeds half the supply voltage - which is regulated by T1, T2 and D1 - its output goes low. Note that this does not happen with HCT or LS types: these are, therefore, not suitable for this circuit.

The LEDs are connected to the output in a manner that ensures that only one of them lights at any one time. The low supply voltage for the IC and the current-source characteristic of the outputs render current-limiting resistors for the LEDs superfluous. The switching thresholds have been chosen to coincide with frequently encountered supply voltages.

The printed-circuit board, which is not available ready made, is designed for surface-mount components, although it will accommodate a number of traditional components. Drawings of the board are available on paper or film at low cost - see the Readers Services section towards the end of this magazine.

If the Type BFR101B SMT FET is not obtainable, a (conventional) BF256A may be used. The SMT type is placed alongside D11 with its gate (the slightly broader terminal) opposite the cathode of the diode. The BFA256 is placed on its flat side alongside D11: its pins should be soldered to the pads between T1 and D3.

The board itself forms the main prong and may, for instance, be potted in epoxy resin to give a sturdy, well-insulated unit. The auxiliary prong is connected to the round pad at the square end of the board.

The circuit is designed for measuring only voltages that do not exceed 30 V.

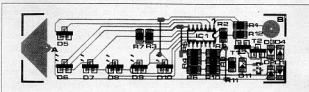

Parts list

Resistors

R1-R6 = 100 k
R7 = 220 k
R8 = 390 k
R10 = 680 k
R11 = 47 k
R12 = 100 R

Semiconductors:

D1-D4 = BAV100
D5-D10 = LED (red)
D11 = 3V9, 500 mW zener
T1 = BC847B
T2 = BFR101B (see text)
IC1 = 74HC04 (not HCT)

089

GENERAL INTEREST

LIQUID-LEVEL MONITOR

The monitor is based on an L4620 from sgs. The internal oscillator of that device, in conjunction with C_{OSC} and R_{OSC} , generates a rectangular signal at 1.6 kHz. This is divided by 32 and the resulting 50 Hz signal is applied to pin 2 of the IC via the sensor driver.

The sensor proper is a humidity-dependent resistor. This may, for instance, consist of two wires suspended in a vessel in a man-

ner that when liquid being poured into the vessel exceeds a certain level, or liquid being taken from the vessel drops below a certain level, pin 3 is short-circuited to earth. The RC network between pins 2 and 3 is a simple band-pass filter with a centre frequency of 50 Hz. This filter is needed only where exact level indications are wanted: in most other cases, Ca and Cb may be

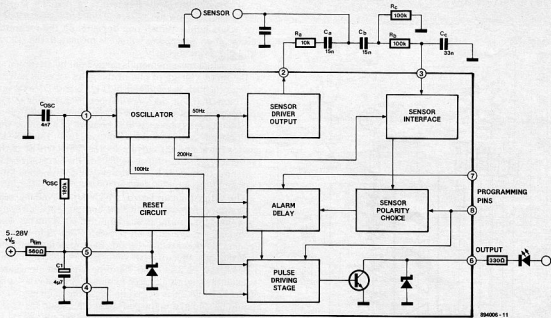

replaced by a wire link.

The sensor interface receives a 200 Hz signal from the oscillator and compares the level at pin 3 with a reference voltage whose value depends on the logic state at pin 2. When that pin is low, the reference voltage is $0.2U_2$; when it is high, the reference voltage is $0.4U_2$. When these levels are exceeded, the interface passes a signal to the sensor polarity stage.

The alarm is actuated by this signal in two ways: (a) when pin 8 is high and the level at pin 3 is higher than the reference voltage;

(b) when pin 8 is low and the level at pin 3 drops below the reference level. All this happens only when the alarm state signal from the sensor interface is constant for not less than ten seconds with pin 7 low, or than 20 seconds with pin 7 high.

In the alarm state, the output at pin 6 can provide a current of up to 300 mA.

The current drawn by the circuit depends on the supply voltage, which may be 5–28 V: at 5 V, it is typically 6.4 mA.

090

GENERAL INTEREST

'ON' INDICATOR FOR GAS-OPERATED FRIDGES

This indicator is intended primarily for refrigerators used by campers or caravan owners. Whether the gas flame is on may be indicated with the aid of a thermocouple, a device that reacts to variations in temperature. It normally consists of two dissimilar metals – here iron and constantan – soldered or welded together at one end.

The e.m.f. produced across terminals A and B when the temperature at the weld varies is applied to the non-inverting input of comparator IC1. Here, the e.m.f. is compared with a reference voltage of 0.7 V applied to the inverting input of the opamp.

When the temperature at the weld of the thermocouple is about 150°C , the e.m.f. across terminals A and B is also 0.7 V. The comparator then toggles and causes the LED to light, indicating that the gas flame is on.

The iron terminal must be soldered to A and the constantan terminal to B.

(U. Münch)

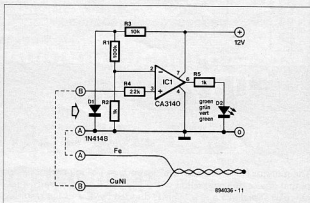

AUTOMATIC FOG HORN

An interesting aspect of the fog horn described here is that it may be constructed for real-size as well as for model boats.

The circuit can emit automatic warning signals in the form —, — —, — ••, •••, and ••••• at 2-minute intervals. Other signals may be given manually.

The circuit is based on a combined CMOS oscillator-binary counter Type 4060. Apart from the clock for the warning signals, this IC also provides the intervals between successive warning signals. The RC oscillator is configured to generate low frequencies. Counter output Q8 is reset to zero every 256 cycles.

The signal generator, IC1, is driven by both the clock and the reset signal from IC2. Basically, it is a 1-in-10 counter running synchronous with the clock, so that one of its outputs is always 1. A reset signal makes Q0 logic high.

The clock enable input, when high, that is, when Q9 is high, stops the counter instantaneously.

When the power is switched on by S1, a reset signal is given simultaneously to both ICs to ensure synchronicity. The 4017 then

begins to pass its signal sequence to the diode matrix. Each single pulse lasts for one second (= dot). The dash in the signals consists of three fused dots. If, for instance, the switch is set to — ••, Q0, Q1 and Q2 each output a single pulse; the three pulses are combined to a dash. The pulse output by Q1 to the diode matrix also becomes available via Q4 and Q6 as two dots. Outputs Q3, Q5, Q7 and Q8 are not used with this switch position. Output Q9 holds the circuit in this state until 120 seconds later a reset from IC2 starts the foregoing sequence afresh.

Transistor T1 amplifies the signal from S1a to a level suitable to operate a buzzer or the horn relay via switch S2. The relay contacts must be able to switch currents of a few amperes.

The power supply should be between 12 V and 30 V, which is reduced to 10 V and stabilized by IC3. The quiescent current drawn by the circuit is very small. In fog, however, it is essential that the battery is charged continuously.

(P. W. Rütters)

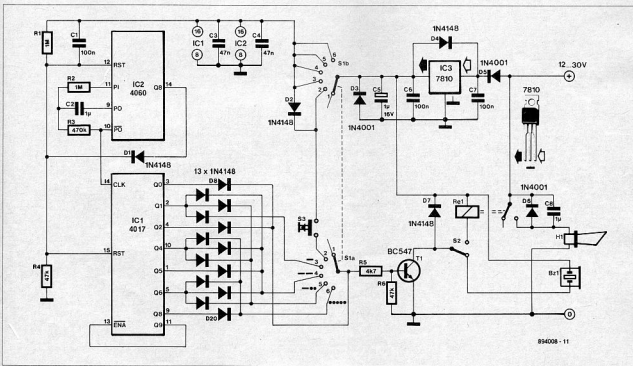

HEADPHONE AMPLIFIER WITH SCART PLUG

The headphone socket of most television receivers is coupled direct to the loudspeaker, so that the headphone volume can not be adjusted separately. This is a serious drawback for the many viewers who are hard of hearing or who want to listen to a programme in high ambient noise (family gatherings!).

The amplifier described here, although designed primarily for use with a television receiver, is also very well suited to use with a hi-fi installation. It provides independent controls for volume, balance, and bass and treble for each (stereo) channel.

The amplifier is designed around two tone-control ICs Type

TDA4290-2 and a stereo amplifier IC Type TDA2004.

The TDA4290-2 ICs have d.c. operated volume and frequency controls. They need few external components and offer low-distortion and low-noise operation. Capacitors C2 and C11 determine the treble cut-off frequency, and C5 and C14, the bass cut-off frequency. The volume control voltage is applied to pin 5. Furthermore, at output pin 2 a reference voltage is available for modifying the potential at control inputs pins 5, 8 and 14. The output signal is available at pin 6, from where it is applied to the output stage via an RC network.

Like the TDA4290-2 ICs, the TDA2004 needs only a few external components to determine the stage gain (R13-R14 and R20-R21; about 40 dB); the bandwidth (R12 and R19; about 22 kHz); and protection against short-circuits and inductive loads.

Because of the asymmetrical power supply, electrolytic capacitors C25 and C27 are essential.

Resistors R23 and R24 serve to match the input sensitivity and headphone impedance to the amplifier; some experimentation with their values may be necessary.

Resistors R17 and R18 enable the electrolytic capacitors to charge, even without load, which prevents clicks in the headphones when these are plugged in.

Some technical data (measured with an output voltage of 1 V at 1 kHz): distortion <0.03%; -3 dB bandwidth 10 Hz to 22 kHz; signal-to-noise ratio 70 dB. The bass and treble controls have a range of 17 dB and 20 dB respectively.

The tone control ICs are provided with a physiological volume control: to bring this into operation, simply interconnect pins 2 and 4.

A power supply of 11-18 V is required. The current drawn by the amplifier with a supply of 15 V is 150-200 mA.

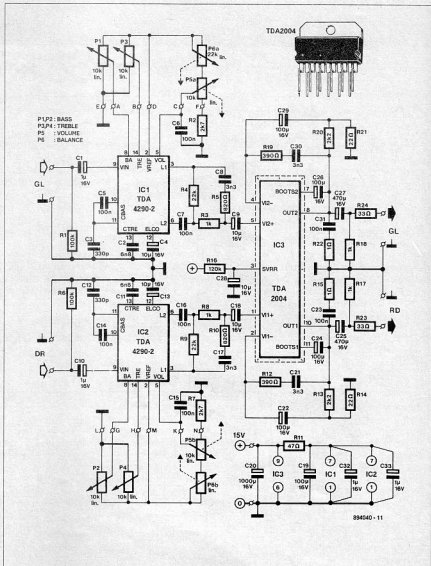

(H. Burchardt)

Parts list

Resistors:

- R1, R6 = 100 k
- R2, R7 = 2k7
- R3, R8, R17, R18 = 1 k
- R4, R9 = 22 k
- R5, R10 = 820 Ω
- R11 = 47 Ω
- R12, R19 = 390 Ω
- R13, R20 = 2k2
- R14, R21 = 22 Ω
- R16 = 120 k
- R23, R24 = 33 Ω

P1-P6 = 10 k linear potentiometer

P7, P8 = 22 k linear potentiometer

Capacitors:

- C1, C10, C32, C33 = 1 μ F, 16 V
- C2, C11 = 6n9
- C3, C12 = 330 pF
- C4, C9, C13, C18, C28 = 10 μ F, 16 V

- C5, C6, C7, C14, C15, C16, C23, C31 = 100 nF
- C8, C17, C21, C30 = 3n3
- C19, C22, C24, C26, C29 = 100 μ F, 16 V
- C20 = 1000 μ F, 16 V radial

C25, C27 = 470 μ F, 16 V

Semiconductors:

- IC1, IC2 = TDA4290-2
- IC3 = TDA2004 (with heat sink)

DIGITAL TRIGGER FOR OSCILLOSCOPES

The circuit described here enables an oscilloscope to be triggered when a pre-determined binary code word is applied to one of the circuit's inputs.

Integrated circuits IC1 and IC2 compare the sixteen inputs with the code set by switches S1 and S2. If one of the inputs has a data word that is equal for not less than 100 ns to that set by S1 and S2, pin 19 of IC1 goes high. Note that, because of the pull-up resistors, open inputs are treated as high.

When pin 19 of IC1 is high, monostable

MMV2 is triggered and outputs a negative pulse from its pin 4 that, depending on the setting of P1, is 0.1–1.5 μ s long. If during that time the pre-determined trigger value disappears, no triggering takes place. Potentiometer P1 is a logarithmic type to enable very short times to be set accurately.

The output pulse from MMV2 triggers a second monostable, MMV1, whose mono time has been set to 1 μ s by R23-C3.

Either the positive signal from the Q output or the negative signal from the Q output,

depending on the setting of switch S3, may be applied to the oscilloscope.

Parts list

Resistors:

- R1–R16 = 10 k
- R17–R20 = 100 k
- R21, R23 = 2k Ω
- R22 = 470 Ω
- P1 = 100 k log potentiometer

Capacitors:

- C1 = 10 pF
- C2 = 47 pF
- C3 = 1 nF
- C4 = 100 nF

Semiconductors:

- IC1, IC2 = 74HCT688
- IC3 = 74HCT123

Miscellaneous:

- S1, S2 = octal DIP switch
- S3 = SPDT switch
- K1 = BNC socket
- 18 crocodile (test) clips
- Enclosure, e.g. OKW A9010 065

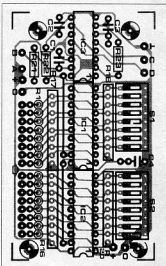
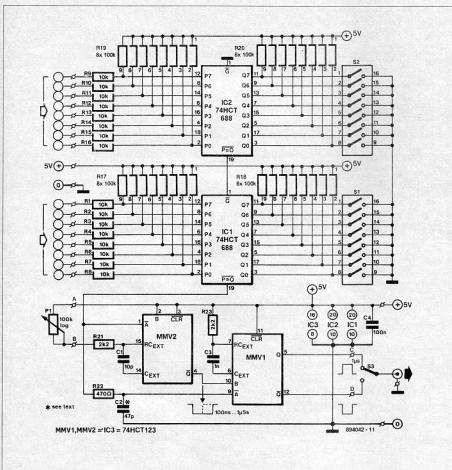

SYMMETRICAL POWER SUPPLY

Integrated circuit L165 makes it possible for a 6–40 V asymmetrical voltage to be converted into a stabilised, symmetrical supply

of ± 3 V to ± 20 V. Only a few external components, like some electrolytic capacitors for smoothing purposes, are needed. Capacitors

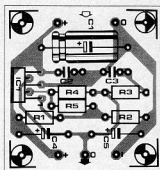
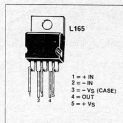
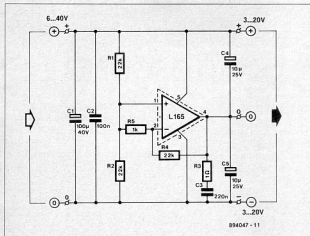

Parts list

Resistors:
 R1, R2 = 22 k
 R3 = 1 Ω
 R4 = 22 k
 R5 = 1 k

Capacitors:
 C1 = 100 µF, 40 V
 C2 = 100 nF
 C3 = 220 nF
 C4, C5 = 10 µF, 25 V

Semiconductors:
 IC1 = L165 or TCA1365

Miscellaneous:
 Heat sink for L165 or TCA1365

C1 and C2 should preferably be fitted as close to the IC as possible, while C4 and C5 should be soldered to the output terminals.

Since the circuit can deliver currents of up to 3 A, heavy-duty wiring and a heat sink for the IC are essential.

The L165 may be replaced by a TCA1365, but that does not fit on the printed-circuit board. If that chip is used, its pins 3 and 4 must be strapped together, and a 220 pF capacitor must be fitted between its pins 5 and 6.

(Source: Siemens)

095

COMPUTERS

AUTOMATIC PRINTER SHARING

The title of this article is a slight misnomer, because the circuit described here does not only allow two computers to share one printer, but it also enables two printers to be connected to one computer.

Basic operation of the circuit is illustrated in Fig. 1. If it is used

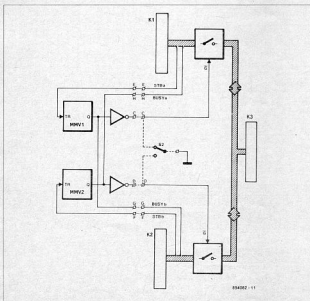

Fig. 1. Block schematic of the printer sharing unit

Parts list

Resistors:
 R1, R17-R21, R37-R40,
 R56-R59 = 1 k
 R2-R16, R22-R36,
 R41-R55, R60, R65 = 10 k
 R61, R66 = 100 Ω
 R62, R63, R67 = 1 M

Capacitors:
 C1, C4 = 22 µF, 16 V
 C2, C3, C5-C9 = 100 nF

Semiconductors:
 IC1-IC4 = 74HC645
 IC5 = TLC555
 T1, T3 = BC557B
 T2, T4 = BS170
 D1, D2 = LED

Miscellaneous:
 S1 = press-button switch
 (1 make contact)
 S2 = change-over switch
 K1-K3 = 36-pole male
 header
 PCB 894082

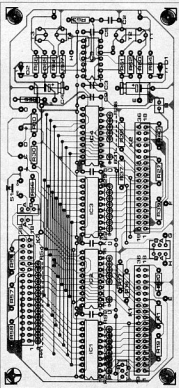

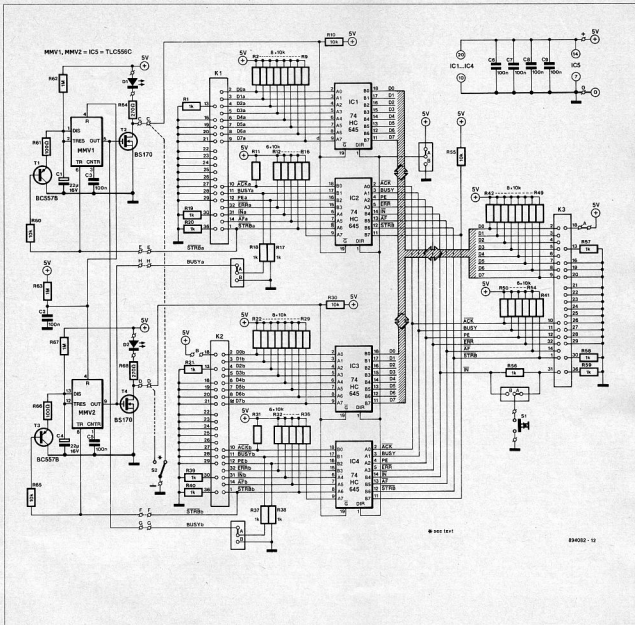

Fig. 3. Circuit diagram of the printer sharing unit

to have two computers share one printer, switch S2 may be omitted since that serves to choose between two printers. As soon as one of the computers starts printing, the associated retriggerable multivibrator is triggered. At the same instant, the electronic switch via which the data must proceed is closed and the BUSY input of the second computer is made high. Because the MMVs are retriggerable, this state will persist for as long as the selected computer continues printing plus 30 seconds (that is, the mono time). Which printer is selected is indicated by an LED.

Unfortunately, the automatic selection may give rise to problems if you use a program that, during printing, needs more than 30 seconds to compute new printer data. The simplest solution to this is to come to an understanding with the user of the second computer. It is also possible to lengthen the mono time by increasing the values of C1 and C4, but that has the disadvantage of making the switch-over very slow.

If two printers are to work with one computer, the MMVs are

replaced by change-over switch S2.

The circuit diagram in Fig. 3 looks more complex than it is, mainly because of the large number of pull-up and pull-down resistors.

Wire links A or B are present at various places: they determine into which direction data are passed. When links A are used, the direction is from two computers to one printer, whereas if links B are fitted, the direction is from one computer to two printers.

The circuit is powered by a printer: depending on the setting, this is the printer connected to K2 or K3. Note that if only one printer is used, this can not be connected to K1.

Also dependent on the setting are wire links C to H, which are placed only if links A are fitted. Otherwise, S2 is fitted and the circuit to the left of links C to H is omitted.

Reset switch S1 is provided to stop the printer in an emergency.

Because of the use of HCMOS ICs, the circuit draws only 50 mA.

VOICE-BAND FILTER

Using only four opamps, this filter provides a sharp cut-off profile: -3 dB at 300 Hz and 2,800 Hz and -40 dB at 100 Hz and 4,000 Hz. Since the attenuation outside the pass band is at least 50 dB, the filter is eminently suitable for use in, say, direct-conversion receivers or as an anti-aliasing network.

Fundamentally, the circuit is an LC filter of which the inductances are simulated by operational amplifiers (for a more detailed discussion of this type of filter, see Ref. 1 and Ref. 2). Note that the opamps affect the filter characteristics: the responses mentioned earlier were achieved with a TL084.

Amplifier IC1 serves merely to compensate losses in the filter.

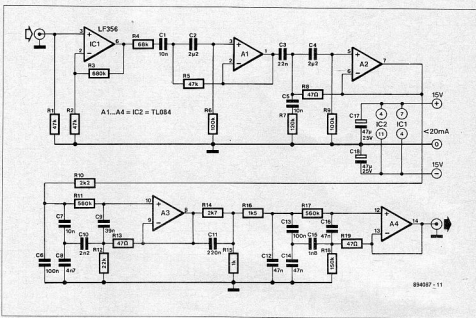

Ref. 1. "Filters Theory & Practice-3" Elektor India. Novembre 1987 p. 11-30

Ref. 2. "The positive Impedance converter" Elektor India November 1987 p. 11-50

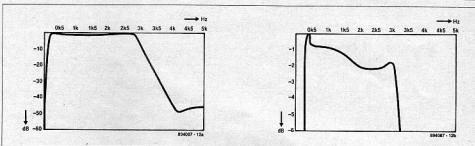

SLIDE FADER UPDATE

The "Computer-controlled slide fader" we published last year (Ref. 1) was based on dimmer chip Type TCA280. In spite of this device being a Philips Components preferred type at the time, we learned from a number of readers that this device was virtually unobtainable. When approached, Philips Components admitted that they had taken the TCA280 out of production without prior warning, and that no pin-compatible replacement was available.

It has taken us some time to find a suitable replacement and have found that the TCA785 from Siemens is a good, but not pin-compatible, substitute.

The vSYNC input is provided with a 50 Hz square wave, which is used internally for mains synchronization. The IC is powered via R2, D3, C1 and zener diode D4.

An internal current source, set by P1 and R5, causes a linearly rising voltage across C3. At each mains zero crossing, C3 is dis-

charged rapidly, so that the potential across it has a sawtooth waveform. The amplitude depends on the setting of P1.

The sawtooth voltage is compared with a control voltage that is applied to pin 11 of IC1 via filter R3-C2. If the sawtooth voltage rises above the control voltage, a pulse is generated at pin 14 or 15, depending on at which part of the cycle the mains voltage is. The two outputs are connected to a triac via diodes D5 and D6, and resistor R6, which enable the triac to be triggered. The instant that the triac begins to conduct is, therefore, dependent on the control voltage at the input, resulting in a voltage-controlled fader. The control voltage may be provided by the slide projector or a potentiometer. In the latter case only, it is also possible to fade 12-V halogen lamps. Zener diode D4 then needs to be replaced by an 8.2 V type.

The fader is aligned by adjusting P1 in the off condition, when

Resistors:

- R1 = 27 k
 R2 = 330 Ω
 R3 = 2k2
 R4 = 10 k
 R5, R7 = 4k7
 R6 = 150 Ω
 P1 = 100 k preset
 P2 = 10 k

Capacitors:

- C1 = 470 μF, 25 V
 C2, C3 = 100 nF
 C4 = 10 μF

Semiconductors:

- IC1 = TCA785
 Tr1 = TIC236 or TIC 246
 D1, D2, D5, D6 = 1N4148
 D3 = 1N4001
 D4 = zener 15 V, 1 W

Miscellaneous:

- S1 = SPST switch
 PCB 894078

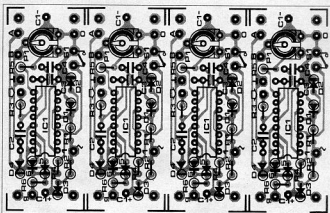
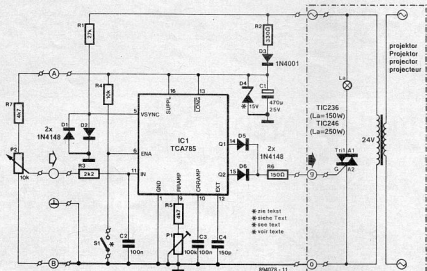

the control voltage is at a maximum, till the lamp just glows.

The slide projector is aligned by setting the relevant potentiometer on the projector PCB to the centre of its travel, when the lamp(s) should be out.

When that is done, the lamp(s) should be switched on and off a couple of times to make sure that the two potentiometers (P1 and that on the projector board) are adjusted correctly.

Since the control characteristic of the TCA785 is different from that of the TCA280, it is not advisable to mix the two devices.

When S1 in the present fader is closed, the projector lamps are off: in other words, for normal operation, S1 must remain open and it may, therefore, in some cases be omitted.

Ref. 1. Eicktor India May & June 1988

098

POWER SUPPLIES

REFERENCE-VOLTAGE SOURCE WITH INDICATOR

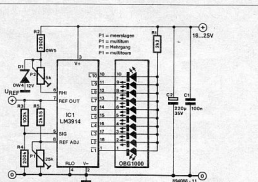

A novel use for a Type LM3914 display driver is described in this article. Since the IC is normally used as an indicator driver for analogue circuits (VU meter, current indicator, and so on), it has an internal, very stable 1.25-V reference source. The reference voltage

is available at pin 7 and may be set anywhere between 1.25 V and 16 V by multi-turn potentiometer P1. It is assumed here that the supply voltage is at least 18 V. The reference voltage is calculated from:

$$U_{ref} = 1.25[1 + P1/R5] + 75P1 \times 10^{-6} \quad (V)$$

The circuit is calibrated by setting P1 to give a reference voltage of exactly 15.0 V, and then P2 to make

LED	U_{ref} (V)
1	1.5-3.0
2	3.0-4.5
3	4.5-6.0
4	6.0-7.5
5	7.5-9.0
6	9.0-10.5
7	10.5-12.0
8	12.0-13.5
9	13.5-15.0
10	15.0-.....

LED10 just light. The other LEDs light in accordance with the set reference voltages shown in the table.

The circuit can deliver a current of up to 3 mA; if higher currents are wanted, it should be followed by a buffer opamp. The

circuit can then be used as a simple variable current source with voltage indication.

As shown, the circuit draws a current of about 30 mA with a supply voltage of 20 V.

099

GENERAL INTEREST

TIME-DELAYED FLASH

The photographing of falling water drops, bullets that tear through balloons or playing cards, and other happenings for which our human reaction powers are too slow, remain a fascinating aspect for many photographers. That the means therefore need not be expensive is explained in this article.

To start with, a light barrier is needed where the fast-moving object can be registered. It will also tell us when the object arrives at the place where it is to be photographed. The time needed therefore is bridged by a time delay circuit.

The circuit of the light barrier is shown in Fig. 1, where D1 and T1 form the light barrier proper. Transistor T2, resistors R3-R5 and capacitor C1 serve to minimize the effects of ambient light and mains hum. Opamp A1 buffers the signal from the light barrier before it is applied to pulse shaper A2. The circuit is very sensitive, although this may largely be overcome by earthing the common supply rail.

The pulse from the light barrier is delayed by the circuit shown in Fig. 2. First, the pulse is used to drive an LED, which facilitates calibrating the circuit. The pulse also

clocks a data bistable, FF1, which is configured as a monostable and determines the time delay. To enable the delay to be set very precisely, two potentiometers are used: P1 (fine) and P2 (coarse). The setting can be made even more precise by using a multi-turn potentiometer for P1.

After the time delay has lapsed, the Q output of FF1 clocks bistable FF2, which is also configured as a monostable. Immediately on being clocked, FF2 generates the ignition pulse for the flash gun. This pulse is applied to the flash gun via T2 and

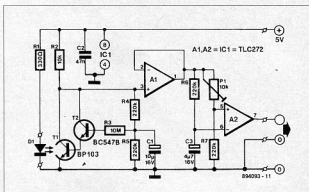

Fig. 1. Circuit diagram of the light barrier

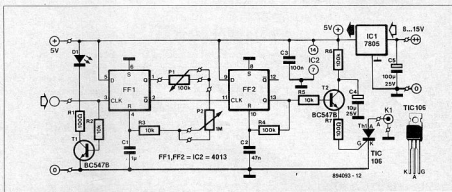

Fig. 2. Circuit diagram of the delay unit

Parts list

Delay unit

Resistors:

R1, R7 = 100 Ω
R2, R3, R5 = 10 k
R4, R6 = 100 k
P1 = 100 k
P2 = 1 M

Capacitors:

C1 = 1 μ F
C2 = 47 nF
C3 = 100 nF
C4 = 10 μ F, 25 V
C5 = 100 μ F, 25 V

Semiconductors:

IC1 = 7805
IC2 = 4013
T1, T2 = BC547B

T1 = TIC106

D1 = LED

Miscellaneous:

K1 = phono socket

C3 = 4.7 μ F, 16 V

Semiconductors:

IC1 = TLC272
T1 = BP103
T2 = BC547B
D1 = LED, red

Light barrier

Resistors:

R1 = 330 Ω
R2 = 10 k
R3 = 10 M
R4-R7 = 220 k
P1 = 10 k preset

Capacitors:

C1 = 10 μ F, 16 V
C2 = 47 nF

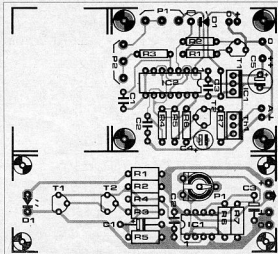

thyristor Th1.

Both circuits are housed on a printed-circuit board that, if desired, may be cut into two. The long part of the board is intended for the light barrier circuit and the almost square part for the delay circuit. Note that since the design started as two independent projects, there are two resistors R1, two capacitors C1, and two circuits IC1.

A problem with electronics for photography remains the flash gun connexion, for which the parts are difficult, and in most places impossible, to obtain. For our prototypes, we used high-quality phono connectors and audio cable, but for the connexion to the flash gun itself, we fabricated a DIY adaptor from a phono socket, as shown in Fig 4, and a flash gun socket that was cut off an extension cable.

CALIBRATION (Electronics)

The light barrier must be calibrated in total darkness with the aid of the LED on the delay board. Adjust P1 until the LED just goes out (= no object in the light barrier). At that point, sensitivity is at its highest. If the circuit proves very susceptible to interference, connect the common power rail to a really good earthing point.

Once that is done, check with P1 and P2 set at minimum resistance (=time) whether the flash gun will work when a water drop falls through the light barrier. If yes, the drop will be seen sus-



Fig. 4. DIY flash gun connector

pending in the barrier (it is, of course, still pitch dark in your work room). If no, the flash gun connexions on K1 must be reversed.

Once the water drop is suspended in the light barrier, its position can be shifted, if desired, by P1 and P2 to where the photograph is to be taken.

CALIBRATION (Photographic)

The shutter of the camera must be set to the B position before photographing the drop of water, since no camera can react fast enough at normal settings. At the flash gun, check whether the automatic exposure facility covers the correct exposure for the photograph: this is, of course, dependent on the background and on the shortest distance at which the flash computer still works. Place the flash gun as close as possible to the object, because the flash duration is then as short as possible.

If you do not trust the automatic exposure, set the flash gun to manual and ascertain from the handbook how long the flash lasts - this is often longer than you may expect.

Next, measure the distance in metres between the flash gun and the object and divide that by the guide number of the flash. Set the stop so obtained on your camera (rounded off upwards for slides and downwards for negatives).

The current drawn by the entire circuit amounts to 20-30 mA.

100

COMPONENTS

R-2R RESISTANCE NETWORK IN SMT

This article describes an interesting SIL R-2R network for use in, say, a digital-to-analogue converter. The network is constructed in surface-mount technology (SMT) and is inexpensive, precise, space-saving and allows unusual values to be obtained. It is described here in a digital-to-analogue converter that uses a CMOS latch Type 4042.

The latch and the associated R-2R network are connected in the

feedback loop of an LF356. The network uses 100 kΩ resistors (the 2R resistors are made up of two series-connected 100 kΩ resistors). The output voltage (in V) of the converter is calculated from:

$$U_o = U_r(R_1 + P_1) / 6R(2^0Q_3 + 2^{-1}Q_2 + 2^{-2}Q_1 + 2^{-3}Q_0).$$

The Q_s in the formula have a value of 0 or 1, depending on the state of the latch output. The factor $(R_1 + P_1) / 6R$ is the amplification A , which can be set between 0.4 and 2.0 by P1.

The supply voltage for the latch, which is also the reference voltage for the network, U_r , may be between 5 V and 15 V: the logic levels at latch inputs D0-D3 and at CLK must be in accord with that voltage. The reference voltage must be decoupled directly at the IC input.

The circuit is calibrated by making the inputs of the latch 0 and adjusting P2 for an output of 0 V from the opamp. Then, load the

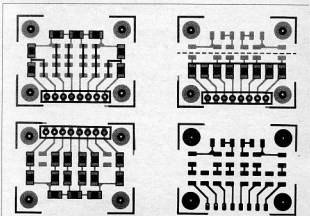
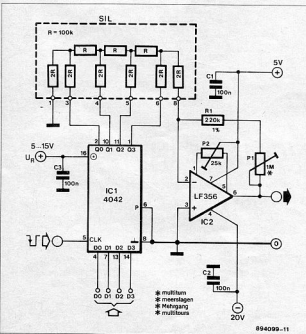

data inputs with F_{hex} and adjust P1 to obtain maximum output voltage.

If a larger number of bits is to be processed, two or more PCBs may be connected back-to-back.

Moreover, the PCB may be used with other components, such

as diodes, capacitors, combinations of resistors and diodes or simple potential dividers for measuring instruments.

The current drawn from the U_r supply is 75 μ A; that from the 5 V supply is about 7.5 mA.

(H. Bierwith)

101

ELECTROPHONICS

BREAK-JACK ADAPTOR

A break-jack adaptor is a means of connecting, say, effects units to the 'send' and 'return' sockets of an output amplifier. In fact, the adaptor is vital there, because the levels of the effects unit(s) and amplifier are normally not compatible. Without its use, overdriving and noise would be the consequences.

The adaptor converts the connexion from a passive into an active one, which is possible with any output amplifier. For that purpose, it uses two voltage amplifiers, A1 and A2. The gain or attenuation of these is set complementary to one another by stereo potentiometer P1.

If we assume that the wiper of P1 is at the centre of its travel, the opamps have neither gain nor attenuation. In other words, in that situation an effects unit at the input would behave exactly as if there were no adaptor. If then P1 is turned clockwise, the input signal is amplified. If P1 is turned anti-clockwise, A1 attenuates the signal, whereas A2 amplifies it.

Effects units with levels ranging from 0.5 V to 1.5 V may be used. Lower levels can be accommodated by increasing the value of R2 and R6 to 33 k Ω maximum. The 'neutral' position of P1 is then no longer at the centre of travel of the wiper, but at about three quarters of the way. The level range is then limited to about ± 3 dB ($\times 2$).

(W. Teder)

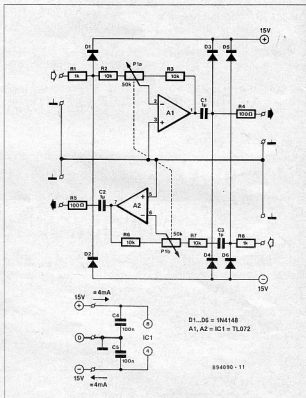

102

POWER SUPPLIES

MAXIMUM/MINIMUM VOLTAGE INDICATOR

Circuits Type TL430 and TL431 from Texas Instruments are active zener diodes with an integral 2.5-V reference source, comparator and output stage. The maximum supply voltage is 30 V at 100 mA. This sort of device makes it fairly simple to construct a variable-voltage indicator.

Resistor R1 has a value of $(U_{in} - 4.5) / 10$: the factor 10 indicates an LED current of 10 mA. Depending on the setting of P1, the LED lights when the input voltage becomes too high or goes out when that voltage becomes too low.

If you build two identical circuits with differently coloured LEDs, you obtain a very effective voltage monitor. The combination is calibrated for given maximum and minimum levels: within

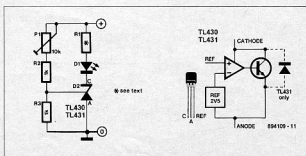

DECOUPLING POWER RAILS

Adequate decoupling of the power rails of most circuits is a seriously underestimated necessity. Particularly in the design of printed-circuit boards, it happens all too often that at the last moment the thought occurs that there is no or insufficient space left for decoupling capacitors, small though these normally are. It is, of

course, not surprising that such negligence often results in spontaneous oscillations in analogue circuits and unreliable operation of digital circuits. Especially sequential digital circuits, such as dividers, counters and bistables are prone to these problems, the causes of which are normally very difficult to find.

Power rails should be decoupled by a capacitor close to the relevant pins of the IC, since the rail has a certain amount of inductance. Variations in the current through this inductance cause a potential drop that manifests itself as a short pulse or spike. The capacitor serves to buffer (that is, to minimize) the current transients.

Current transients arise, for example, during the switching of logic circuits, since all sorts of parasitic capacitance are charged or discharged during the change in output level. Also, just at the instant the change is taking place, the transistor in the output stage that switches to earth and the transistor that switches to the positive rail are conducting simultaneously. This means that for a very short time the power supply is short-circuited. The 50-ohm resistors in TTL logic circuits limit the consequent short-circuit current, but 4000 and HC(T) series CMOS circuits have no such protection. It is for that reason that CMOS circuits need to be decoupled even more effectively than TTL circuits. Note that the static current, which is many times greater in TTL circuits than in CMOS circuits, has no bearing whatsoever on the degree of decoupling needed.

Decoupling capacitors must be connected with their terminals cut as short as feasible direct to the supply pins of the relevant IC.

The effectiveness of a number of standard types of capacitor is discussed below.

- The **wet aluminium electrolytic capacitor** has a fairly large self-inductance owing to its construction (rolled foil). Nevertheless, it performs very well as a decoupling device. Its value does not matter much: from 1 μF to 10 μF are suitable values. Disadvantages are a relatively short life and fairly high leakage currents.

- The **dry aluminium electrolytic capacitor** is in the same league as the tantalum capacitor. Its life is considerably longer than that of the wet electrolytic type. Like tantalum capacitors, they are excellent for decoupling but, again like tantalum types, they are relatively expensive.

- The **tantalum capacitor**, although relatively expensive, is widely used for decoupling purposes, because of its excellent all-round properties.

- The **ceramic capacitor** is the decoupling capacitor par excellence. It is inexpensive, has excellent h.f. properties, so that relatively low values (22 nF to 100 nF) may be used, while its large tolerance and non-linear temperature behaviour do not matter for decoupling.

- The **metallized film capacitor** (MKT, MKS, and so on) is, perhaps, too good for decoupling purposes. This is because the capacitor and the self-inductance of the power rail form an oscillatory circuit. The low losses of metallized capacitors cause underdamping of the occasional oscillations. It is interesting

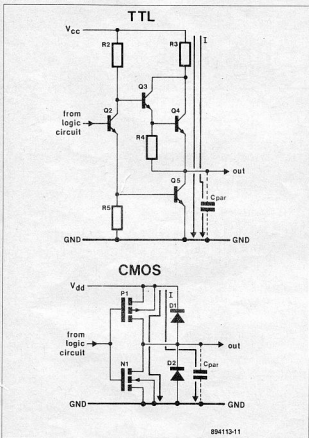

Fig. 1. Because of the internal 50 Ω resistor, TTL circuits have some inherent short-circuit protection that CMOS circuits have not.

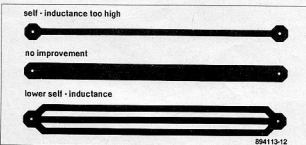

Fig. 2. The self-inductance of power rails may be reduced by using two or three rails in parallel.

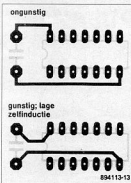

Fig. 3. It is better to place the rails close together than to separate them.

to note that the much higher losses of ceramic capacitors are, in this respect, a definite advantage.

Some guide lines for effective decoupling are given below.

- Provide each and every PCB with its own 47 μF to 100 μF electrolytic buffer capacitor.
- Both input and output of voltage regulators should be decoupled by a capacitor of at least 100 nF (positive regulators) or 220 nF (negative regulators).
- Simple logic gates should be decoupled by one capacitor of not less than 22 nF per four ICs if these are close together. More complex circuits like bistables need one capacitor for every two ICs, while counters and dividers should have one capacitor for each IC. Individual ICs should have a separate decoupling capacitor.

In addition to the use of decoupling capacitors, the self-inductance of the power rails can be reduced by two or three rails in parallel as shown in Fig. 2. Research has shown that increasing the diameter of the rails merely reduces the resistance, but not the self-inductance.

Another aspect is that the self-inductance of the rails is directly proportional to the enclosed surface. It is, therefore, better to place them close together than to separate them—see Fig. 3.

In hybrid circuits, the analogue part may be separated from the digital part by a choke in series with its power rail, but only if the linear part of the circuit does not experience regular variations in the current, because then things may get worse instead of better.

104

GENERAL INTEREST

LIGHT(S) OUT?

Described here is a useful indicator to warn of lights that have not been switched off when they should have. It is small enough to be fitted inside most switch housings.

When the switch is open, the thyristor is off, so that the bridge rectifier is fed with only the positive half cycles of the mains via D3. Consequently, there is no d.c. voltage across C3.

When the light is switched on, and the load current exceeds some 2 mA, there is a sufficiently high voltage drop across D1-D2 to cause the thyristor to conduct. The full mains voltage is then present across the bridge rectifier, C3 is charged and relay Re1 is energized. The relay may be used to switch on a visual indication as shown here or it may be used to set off an audible alarm.

The relay should be a 24 V, 1200 Ω type for PCB mounting. It may be omitted and the LED with its bias resistor connected direct across terminals A and B.

(R. Lambach)

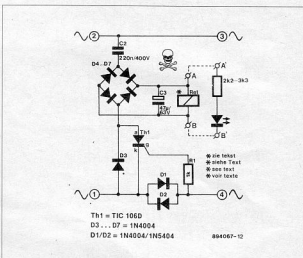
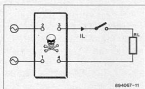

105

ELECTROPHONICS

MODULAR GUITAR AMPLIFIER

A guitar amplifier may be constructed in a simple way with the aid of a Type HY83 module from ILP. The module comes complete with an instruction manual. The complete amplifier fits very nicely in a 2-unit high 19-inch cabinet as shown in the adjacent photo-



graph. In the back of the cabinet can be seen the mains transformer, the main PCB and the power amplifier - here a Type HY124 from ILP. At the centre of the cabinet are the reverberation springs. The guitar amplifier module is located direct behind the

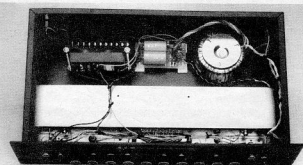

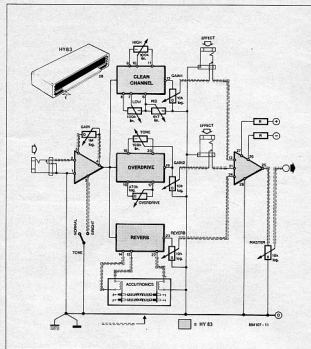

front panel and is mostly hidden from view by wiring. To suppress mains hum, it is recommended to fit a stout earth rail closely along the module and the potentiometer: all earth connexions may then be made to this rail. Note that screens must be earthed at one side only.

The use of light, screened cable in most positions, except for the power supply and power amplifier output, is recommended since the connector terminals are very close to one another.

The HY83 comes complete with a front panel foil that may be used with a 1-unit high as well as with a 2-unit high 19-inch cabinet.

(ILP Application

106

GENERAL INTEREST

DONALD DUCK GENERATOR

To speak like Donald Duck, you need not inhale helium: you can leave it to the circuit described here.

The voice signal from the microphone is first amplified in A1 and then divided into four frequency ranges by band-pass filters A2-A5. The four signals are passed through half-wave rectifiers A6-A9. During the negative half cycles, the opamps invert the signals with unity gain, since the diodes then conduct. During the positive half cycles, the diodes are in the blocking state.

The result of this is that the frequency of the signal at the junction of the diodes and the feedback resistors is twice that of the

input signal at the relevant rectifier. This explains why the frequency range has to be divided into a number of ranges: the more ranges, the smaller the intermodulation distortion.

The rectifier stages are followed by another set of band-pass filters that are tuned to twice the frequency of the filters preceding the rectifiers.

The four signals are then recombined to make Donald Duck speech available at the output of IC5.

The circuit draws rather less than 50 mA from the 5-V supply. A small 5-V mains adaptor is, therefore, more than adequate.

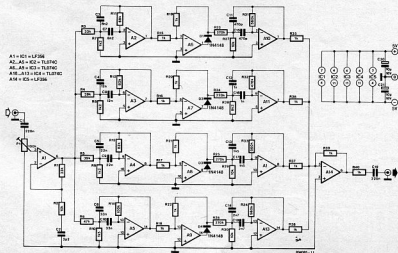

Timer cum Transistor Tester KP-982

KP-982 is a mains operated tester which can check Timer 555 for normal operation such as specified drain, symmetrical waveform output, dc offset etc. It can test op. amp 741 or other similar op-amps for input for input output faults. Transistors can also be tested alongwith measurement of their beta gains with the help of coloured LEDs.



BMP Marketing Pvt. Ltd. • Lal Bunglow
• Jyoti Studio Compound • K.B.A. Irani
Bridge (Kennedy Bridge) • Bombay-400
007 •



Electronic Instrument Laboratories •
B69/004, Anand Nagar • Chhatrapati
Shivaji Road • Dahisar (East) • Bombay-
400 068 •

Up-Down/Stroke Counter (U.D.C. 500)

UDC-500 sold by BMP Marketing is a 5 digit presettable Up-Down counter with/without memory. Memory retains current COUNTER & RELAY status in case of power failure. UP or DOWN counting mode is selected automatically attributed to forward or reverse rotation of the spindle if used as a revolution counter.

It can also be used as a single stroke or double stroke counter as needed in offset machines (textiles etc.)

UDC-500 can accept sensing inputs from variety of sensors such as microswitch, proximity switch, opto-sensors etc. It finds application in winding machines - offset machines textiles etc.

Programmable Clock Timer

ION Electricals have developed a microprocessor based real time clock with programmable timer. Programs can be either set for either arc time operation, daily except the weekly holidays or the working week. The timer can store 16 programs and with external relays logic four different electrical devices can be automatically switched ON/OFF.

A LED display shows the time in 3 different modes. A six button key board on the front panel facilitated the function of setting the clock, changing the display mode, entering a program can stop the relay operation whenever desired. The timer can be used for switching on/off lights, sirens and operation of appliances like heaters/air conditioners.



ION Electrical • 1/1 Mahalaxmi Engg.
Estate • 571 L.J. Cross Rd 1 • Bombay-
400 016 Bombay-400 016 • Tel: 467735,
468157 •

Thyristor Modules

Silicon Power Electronics has introduced half-controlled and full-controlled isolated single phase thyristor modules with current capacity ranging from 25 to 63 amps and repetitive peak-off-state and reverse voltage upto 1600 volts. The half-controlled module consists of two

SCR's and two diodes alongwith a free-wheeling diode. The application of half controlled connection is that with a controllable circuit when inverter operation is not required, only two of the four arms need be controllable and in the other two positions rectifier diodes can be used. The advantage of a half controlled single phase module is that the cathodes of both the thyristors have the same potential and this simplifies the triggering circuit. Function of the free wheeling diode by-passes the current from the bridge components and protects them from over-currents due to the loss of bridge control. The full-controlled thyristor single phase module consists of four SCR's designed for controlled panel operation. Active components are isolated from the body for the isolation voltage of 250C volts a.c. Number of modules can be mounted on one heat-sink. With a suitable heat-sink this module can draw 60 Amps current easily. These modules find application for control of power supplies for electronic equipment, d.c. motors, UPS systems, controllable battery chargers, a.c. and d.c. drives etc.

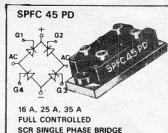

Doshi Enterprises • 304, Goradia Houses
• 104, Kazi Sayed Street • Vadgadi •
Bombay-400 003 • Tel: 330280 •

NEW PRODUCTS

Marvel Products • 208, Allied Ind. Est. •
Mahim • Bombay-400 016 • Tel: 468346/
466846

input signal voltages are 110 V, 220 V and 440 V and option for input signal voltages to vary from 10 V to 500 V AC. Single Phase. LED display clearly indicates the frequency.

Digital Auto/Manual Multimeter

PLA introduces DM-20AR Digital Auto Manual Multimeter. Features include: 4-1/2 digit display for high resolution; auto/manual modes; swift auto-ranging; frequency measurement facility in manual mode; audible and visual continuity tones for quick checks for opens and shorts; touch-hold gives the user a spare pair of hands input protection alone; auto battery test and auto polarity; and a one year warranty.



Pla Electro Appliances (P) Ltd. • Thakor Estate • Kurla Kirool Rd • Vidyavihar (W) • Bombay-400 086.

SINGLE PHASE SILICON BRIDGE RECTIFIERS

Silicon Power Electronics has introduced miniaturised, 1.6 cm x 1.6 cm square isolated silicon single phase bridge rectifier in the current range of 4, 6 and 10 amps with peak inverse voltage upto 1600 volts. These bridges have metal base and adjustable lead connection. Electronically isolated active components and terminals have a maximum high-pot-test voltage of 2500 volts a.c. These bridges have operational/storage temperature rating of -55 C to 150 C and blocking voltage from 100 volts to 1600 PIV. RC network can be used only on DC side for voltage surge protection. These are suitable for chassis and PCB mounting. These silicon bridge rectifiers find applications in general power supplies, input rectifiers for variable frequency drives, rectifier for dc motor field supplies, battery chargers, UPS systems, emergency light, low power controlled panels, stabilizers, laboratory equipments, process control equipments etc.

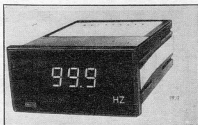

MECO INSTRUMENTS PVT. LTD. • Bharat Industrial Estate • T.J. Road • Sewree • Bombay-400 015 • Tel: 4137423/4132435 •

POWER CONNECTORS

G.H. INDUSTRIES introduces Power Connectors Pitch 3.96 mm, 5.08 mm, 5.0-7.5 mm, 5.0 mm Range : 2 Way to 22 Way.

Male Square Pin Headers are also available with or without Friction Lock, Straight or Right Angle. Current - Rating 7.0 Amps. Voltage 250 Volts.

External & Internal Circlip Pliers

Marvel Products introduces External & Internal Circlip Pliers with replaceable tips used for electronic, Xerographic, automobile and various industrial assembly lines.

Non slip handle made out of glass filled nylon moulded. The plier body is fitted with a return spring.

Replaceable tips: bent, straight, angular tips can be replaced by unscrewing the 3 mm grub screw. Allen key for replacing tips and spare tips are packed in one pouch.

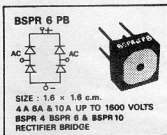
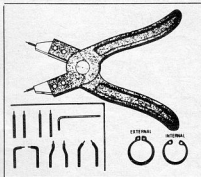

Railton Electronics • 3/C, Madan Street • 2nd Floor • Calcutta-700 072 • Tel: 275488 •

3 DIGITAL LINE FREQUENCY METER

"MECO has introduced a high accuracy, 3 digit Frequency Meter for measuring line frequency in Control panels, Sub-stations, Power Plants, Generating sets, Distribution centres, etc.

The instrument is housed in standard ABS 1/2 DIN case 96 x 48 mm with depth of 150 mm. Ranges available are 0-99.9 Hz with accuracy of 0.1 Hz and 999 Hz with accuracy of 1 Hz. High accuracy and long term stability is achieved by incorporating a crystal controlled clock generator. The operating voltages and

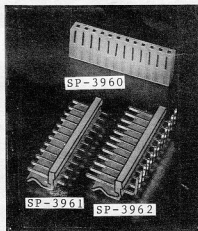

G. H. INDUSTRIES • 84-B Government Industrial Estate • Kandivli • Bombay-400 067 •

Photoelectric Switch

Electronic Switches have introduced a miniature a miniature photoelectric set with infrared beam consisting of separate transmitter and receiver with built-in amplifier and prewired cable. Solid state design provides positive detection of opaque objects and does not get affected by vibration or ambient light conditions.

Working on 10 to 24 V DC supply these are available in light and dark switching models. These switches have wide applications in non contact sensing, switching, controlling and regulating various processes etc. in Packaging, film, paper, chemical, pharmaceuticals, automobiles and other industries.

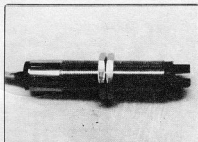

Electronic Switches (Nasik) P. Ltd. • Nahush • Gangapur Road • Nasik-422 005 • Tel: 0253-78452 •

Portable Data Entry Unit

Oriole Services have developed a Portable Data Terminal PDT-1. This comes with 84 keys IBM-PC typefull travel mechanical key-board and has a Two line Liquid Crystal Display, each line of 40 characters. Standard data memory 48 KB Operational features; Standard Insert/Delete Function and UP/Down scrolling available directly through keys, Ni-Cd battery back up, Automatic battery Charging. Power requirement is 230V AC, 100 mA. The form filling firmware allows formatted data entry in a d Base user programmable structure. Optionally cassette interface available with the terminal.



Sinbros Distributors • 9, Sahakar Bhanvan • 2nd Floor • Narayan Nagar • Ghatkopar (W) • Bombay-400 086 •

PCB Storage Rack

Circuit Aids Inc introduces Model CR-21-2 EC, cost effective PCB Storage System suitable for horizontal storage of PCBs prior to and after soldering. Features easily adjustable Antistatic grooves to suit various sizes of PCB upto a maximum of 42 numbers.

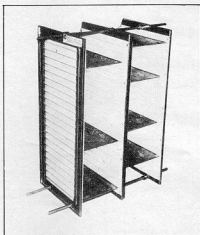

Circuit Aids Inc. • No. 451, II Floor • 64th Cross • V Blk • Rajajinagar • Bangalore- 560 010 • Tel: 359694 •

16/12 Tunes Bell or Kit

Electronics Hobby Centre has developed 16, 12 & 1 Bell Kits as well complete assembled bells. The bell kit is incorporated with programmed IC which gives famous time of Jingle Bell etc. The kit is available with cabinet component and circuit diagram for easy assembling. The cabinet is available in different attractive plastic moulded colors. This is most useful practical project in Electronic Certificate or diploma courses.

The bell works on 3 volts cell by pressing the push button switch once, 5 to 7 second music is available then it stops automatically. This can be used as a door bell or call bell in homes, offices, Banks, hospitals, factories etc.

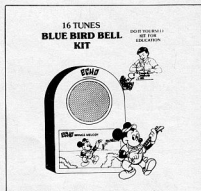

Electronic Hobby Centre • F-32, Band Dham Industrial Estate • Marol Maroshi Road • Andheri (E) • Bombay 400 059 • Tel: 6366123 •

UHF/VHF Converter

Elicon is manufacturing UHF & VHF Converter meant for converting the full range of UHF Brand IV (channel 21 to 39) so that they can be viewed on an ordinary B/W TV (Channel 4). Having a high gain and low noise figure having a stabilised power supply and operating from 220 V AC supply. It is also useful for computers and video games if their output is in the U.H.F. range.



Electronic Instruments & Controls • 4319, 3-Ansari Road • Daryaganj • New Delhi-110 002 •

NEW PRODUCTS

TIMERS

Vectrol Engineer has introduced solid state timers. "ON delay" and "Instantaneous pick up & delay drop out" timer relays are provided with dual operational voltages so as to reduce the stock inventory. Available in the time ranges 0-30, 0-60, 0-120, 0-180 sec maximum, the timer have two sets of delayed output change over contacts for customers control wiring. These timers are used in electrical & instrument control panels for a member of applications to achieve a definite functional requirement related to time. Vectrol also offers ON-OFF sequential (Cyclic) & complex sequential timers having number of events. Timers can be manufactured to suit the customers specific requirements.

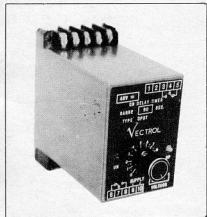

Vectrol Engineers • 4A/32, Versova View Co-Op Hsg. Soc. • Four Bunglow Road • Andheri (W) • Bombay-400 058 •

Telephone Call Accounting System

Teleguard is a microprocessor based Telephone Call Accounting system, which provides automatic print out of number dialled and duration of calls made from a telephone or its extensions. Red print out distinguishes STD, ISD calls. Serial number is also recorded automatically to ensure completeness of information. Red and green led indication shows line usage and dialling activity. It consumes low cost standard paper roll and typewriter's ribbon. Its heavy duty printer ensures continuous operation.

The system is connected parallel to the telephone line and operates on 220 volt-main and has optional battery back up. Ideal for Offices, Industries, Shops, Hotels and Restaurants etc.

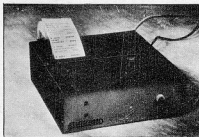

Five Star Commercial Centre • 5-A, Madhya • Sector 7-C • Chandigarh-160 019.

Digital Wattmeters/ Megawattmeters

"DELTA" Control Engg. Corp. offer Digital Wattmeters for power measurements in DC, Single-phase & Three-phase AC system. Ranges are from microwatts to megawatts to suit various voltage and current inputs. Accuracy of + 0.5%, + 1 digit or better is assured over very wide power factor of 0.05 - unity + 0.05 by the use of high precision analog multiplier IC. 3½, 4½ digits, 12.5 mm LED display is convenient to read.

Official calibration certificate from IDEMI, Bombay-400 022 can be provided. Application range from lamp industry, sodium vapour lamp ballast industry, electrical heaters manufacturer, motor & switchgear industry and power utilisers.



Delta Control Engineering Corporation • C-224, Shreyas Industrial Estate • Western Express Highway • Goregaon (E) • Bombay-400 063.

Printed Circuit Board Terminals For 2.5 Sq. mm

CHEMTRONICS INDIA offers individual connectors that can be stacked together for the required number to form a multiway, suitable for international standard module dimensions of printed circuit boards mountings. Connection is by soldering of pins and screw clamping the wire termination.

These PCB terminals are housed in industrial polyamide or which are polypylene housings. They have brass conductors, which are tin plated after nickel coated.

These PCB terminals can accept conductors of 2.5 Sq. mm with rating of 500 Volts-15 Amps.

Useful to electronic Instruments, equipments manufacturers, Computer manufacturers, Television & consumer Electronics product manufacturers, Defence & Dept. of Atomic Energy etc.

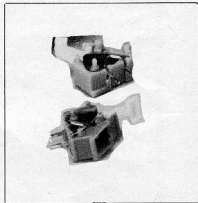

CHEMTRONICS INDIA • B-4, Plot-10 • Above I.C.B • H.F.S. Road • Bombay-400 060 • Tel: 6329536 •

Digital V-A-F Meter

Jivan has introduced Digital V-A-F meter. This measure voltage, Ampere & Line Frequency. It has a compact size of 96 (H) x 96 (W) x 170 (D) mm. It directly measures voltage upto 600 V, with P.T., it can measure any desired voltage. The current range is upto 10 A, but with C.T., it can measure any desired current. The frequency range is from 20.000 to 99.99 Hz.

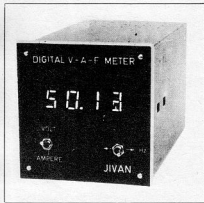

Jivan Electro Instruments • 394, GIDC Estate • Makarpura • Baroda-390 010 •

Sequential Timer Controller

S.S. Controls has developed a fully solid state MC-10 Sequential Timer controller. Having 10 A.C output channels which cover ON sequentially for a fixed duration of time. Both ON/OFF timer period are continuously variable by means of potentiometers. ON condition is indicated by red LED. Each channel has an opto isolator for achieving total isolation from the mains for safety. The unit can be used for less than 10 outputs.

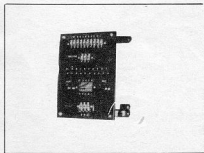

The operation cycle does not stop if one of the channels develops a fault but goes on to the next channel at the set time interval. Applications includes power recovery in powder coating, cement industry etc.

S.S. Controls • 60, A-6/116 Jolly Jeevan • L.I.C. Colony • Borivli (W) • Bombay-400 103 •

H.R.C. Fuse Fittings

Kaycee Industries Ltd., have introduced H.R.C. Fuse Fittings, type 'KF'. Available in 20/32/63 AMP, 500 volts, suitable for front wiring at both ends and tested as per IS 9224 for High Voltage Test, Insulation Resistance Test and Temperature Rise. Salient features include. Base & carrier moulded from High Grade Phenolic Compound which is non-flammable and non-hygroscopic with black hard gloss finish surface. Phosphor Bronze contact clips. Block made from brass. Visible fault indication through window on carrier. Monolithic brass base contact block with adequate hole, suitable for aluminium cable.

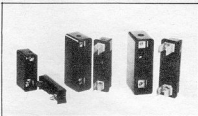

Kaycee Industries Ltd. • 32, Ramjibhai Kamai Road • Ballard Estate • Bombay-400 038.

Shaft Encoder

HENGSTLER of Japan offer optical Shaft Encoder in three Models 613/614/616 (DS Series). Pulses per revolution (P/R) are from 4 to 1000. Operating on 5V DC 12V DC with ripple tolerance upto 5%, these have a frequency response of 30 KHz with output rising falling time of less than 2 micro seconds. These encoders are tested to withstand severe environmental conditions. Life expectancy is upto 7200 million revolutions and they find applications in Machine Tools, Packing Machines, Testing Equipments etc.

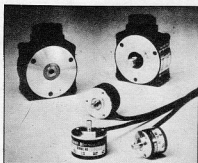

Universal Automation (Agencies) • 47, Mitrmandal • Pune-411 009.

Annunciator Windows

Metal king manufacture Annunciator windows of full Fibre-Glass body. These windows are heat-resistance and are available in four sizes 70 x 52, 65 x 50, 70 x 35, and 55 x 30. The snap-fit window frame in provided in ABS. The fascia plate of Acrylic are of Imported and available in Clear, White translucent - (Opal) and other transparent colours.

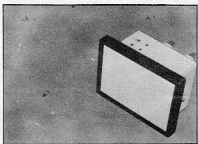

Metal King • 2/9, Meghal Industrial Estate • Devidayal Road • Bombay-400 080 • Tel: 5618978/5604769

Every feature of the 8085 CPU and its peripheral chips can now be studied in complete detail

using

ILC V2

The ONLY
Microprocessor
Trainer
With highly
advanced features

- Battery back up for RAM.
- 8085 CPU operating at 3 MHz.
- System monitor with Operating System like features and CALL function facility for calling system services through user programs.
- Full memory expansion possible.
- Machine single stepping.
- 24 highly reliable dual function keys.
- Small size convenient for embedded system applications.

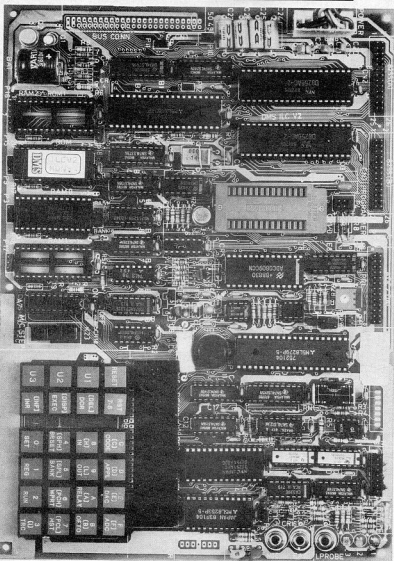

*It's like being
right inside
the 8085 chip.*

- 8255 for parallel I/O.
- Intelligent EPROM/EEPROM programmer.
- Onboard DAC.
- Onboard ADC.
- Miniature Speaker.
- 8279 Keyboard & Display Controller.
- Opto isolator.
- 8251 for serial communications. Upload/Download from Host.
- Programmable RS 232 port.
- Logic Probe.
- 6 digit display.
- Real Time Clock.
- Cassette interface.

For further information, write or call:

Central Sales Office:

112, Hill View Industrial Estate, Amrut Nagar, Off L.B. Shastri Marg,
Ghatkopar (West), Bombay 400 086.

Tel: 583908, 586514 Tlx: 011-71801 DYNA in FAX-(91)22-358171

Branches: ■ PUNE-Tel: 336907 ■ BANGALORE-Tel: 579757 ■ INDORE-Tel: 7986

Distributors: ■ NEW DELHI-Tel: 270832 ■ MADRAS-Tel: 422705

■ CALCUTTA-Tel: 261870 ■ SECUNDERABAD-Tel: 825775

DMS

**Dynalog
Micro-Systems**



SPAI

mp

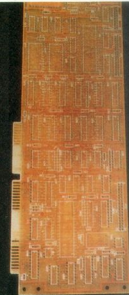

FILE NO.
E-95743



MAKE THE RIGHT CHOICE

High reliability from Micro-pack,
the pioneer manufacturers of

- ★ Fine line double sided PCBs
- ★ Multi layer PCBs upto 10 layers
- ★ Multi level — PTF
- ★ Surface Mount Assembly
- ★ Functional Gold plated PCBs
- ★ Tin-lead fused or SMOBC finish
- ★ State of the Art.

Micropack Limited,
Sri Raghavendra Complex,
2805 & 2807, 10th Main, 4th Block,
Jayanagar, Bangalore-560 011.
Phone: Off. 643004, 643664,
Cable: MICROPACK TELEX: 0845-8764 PAC IN

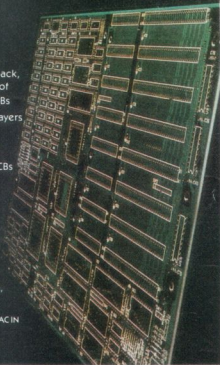
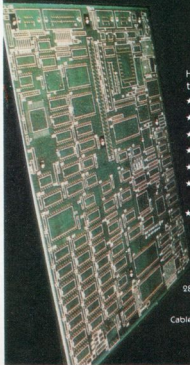

GROWEL ushers in a new era in the INDIAN PCB scenario.....

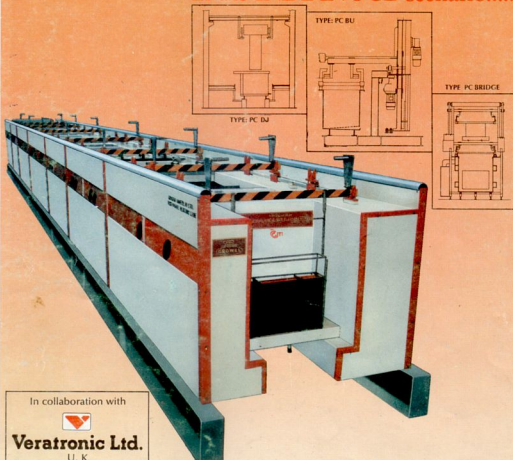

In collaboration with



Veratronic Ltd.
U. K.

Grauer & Weil (India) Ltd., trail blazers in the electroplating field, offer complete printed circuit board plating plants manufactured in India.

Standard plants with throughputs of 3000 to 50,000 sq. meters per year (single shift basis) can be offered for panel, pattern, desmear and nickel gold plating. Optional configurations are available upon request.

Plants incorporate fully automatic microprocessor based material handling systems. These are capable of catering to simple as well as to the most complex

process cycles calling for random selection for multiple product mixes. Supporting features such as CRT terminals, data-logging, production reports and self diagnostics are available for on-line process chemistry analysis and auto-dosing facilities.

Complete range of PCB plating chemicals manufactured under license from the world-renowned ENTHONE INC. of U.S.A. is available to support our process chemistry.

Why not let us supply your requirement of PCB Plating Plants?



GRAUER & WEIL (INDIA) LTD.

Sukh Sagar, N. S. Patkar Marg, Chowpatty, Bombay-400 007.

PHONE : 811 1961, 811 1481, TELEX : 011 75791 GRAMS :-WISHWELL

Branches: BANGALORE, CALCUTTA, DELHI, LUDHIANA, MADRAS AND SECUNDERABAD.

Where the science of plating is transformed to a fine art.